

Carmel Area Wastewater District
Tertiary WDR Order 93-72 Annual Report 2023

California Regional Water Quality Control Board
Central Coast Region
895 Aerovista Place, Suite 101
San Luis Obispo, CA 93401

Document
Date: 1/31/2024

Submit this Self Monitoring Report to: centralcoast@waterboards.ca.gov

FACILITY NAME: Carmel Area Wastewater District Wastewater Treatment Plant

FACILITY ADDRESS: 26900 State Route One
Carmel, CA 93923

CONTACT PERSON: Edward Waggoner

JOB TITLE: Operations Superintendent

PHONE NUMBER: (831) 257-0437

EMAIL: waggoner@cawd.org

WDR ORDER (Permit) Number: 93-72

WDID NUMBER: 3 270101001

PERMITTED FLOW (see facility WDR Permit): 1,800,000 gpd

AVERAGE WASTEWATER FLOW (over monitoring period): 819,000 * gpd

TYPE OF REPORT: Annual Semiannual Quarterly
 Monthly Other: _____

REPORTING PERIOD: 01/01/2023 TO 12/31/2023

MONITORING PERFORMED DURING THIS PERIOD (check all that apply):

Groundwater Lab Reports Recycled Water
 Treatment System Effluent Solids Disposal Disposal Area
 Treatment System Influent Water Supply Use Area
 Source Water Monitoring Other: _____

Violation(s) during this monitoring period? YES NO

Parameter(s) in Violation: *Pursuant to Standard Provisions¹ see footnote on next page, monitoring reports must contain date of violation, explanation of cause and corrective actions planned or taken to prevent recurrence. Please include parameter(s) and date(s) of violation in space provided below. If space is insufficient, include an independent discussion containing explanation of cause and corrective action within monitoring report.*

Discharger Comments:

* Influent Plant Flow, note CAWD has two separate discharge permits R3-2014-0012 for ocean discharge and #93-72 for reclamation discharge. Average GPD ocean discharge average was 618,000 GPD for 2023, and average daily reclamation discharge to golf course irrigation storage was 819,000 GPD for 2023.

Submit this self-monitoring report to centralcoast@waterboards.ca.gov in searchable PDF format. Include attached cover sheet and signature page. DO NOT submit via US mail.

In accordance with the Standard Provisions¹ and Reporting Requirements, I certify under penalty of law that this document and all attachments were prepared under my direction or supervision following a system designed to assure that qualified personnel properly gather and evaluate the information submitted. Based on my knowledge of the person(s) who manage the system, or those directly responsible for data gathering, the information submitted is, to the best of my knowledge and belief, true, accurate, and complete. I am aware that there are significant penalties for submitting false information, including the possibility of fine and imprisonment.

Print Name: Edward Waggoner Title: Operations Superintendent

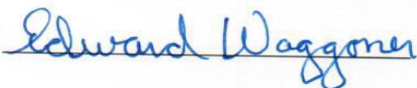
Signature: *  Date: 1/31/2024

*All reports shall be signed by one of the following:

- a. For a corporation: by a principle executive officer of at least the level of vice president.
- b. For a partnership or sole proprietorship: by a general partner or the proprietor, respectively.
- c. For a public agency: by either a principle executive officer or ranking elected official.
- d. For a LLC: either a member or manager given signing authority by the operating agreement of LLC.
- e. a "duly authorized representative" of one of the above.

¹ Electronic access to Standard Provisions: [https://www.waterboards.ca.gov/centralcoast/board decisions/docs/wdr standard provisions 2013.pdf](https://www.waterboards.ca.gov/centralcoast/board%20decisions/docs/wdr_standard_provisions_2013.pdf)

Table of Contents

Coversheet	- 1 -
Table of Contents	- 3 -
Introduction	- 4 -
Section A: Data Tables and Graphs	- 12 -
Section B: Compliance and Performance	- 17 -
Section C: Flow Evaluation	- 18 -
Section D: Operator Certification	- 20 -
Section E: Operation and Maintenance	- 21 -
Section F: Laboratory Information	- 22 -
Section G: Sludge Management	- 22 -
Section H: Pretreatment	- 22 -
Section I: Salt and Nutrient Management Plan	- 22 -
Section J: Collection System Management Plan	- 22 -
Section K: Mercury Seals	- 23 -
Section L: Figures	- 23 -
Lab Reports	- 25 -

Introduction

Facility Objective: Carmel Area Wastewater District protects public health and enhances the environment by collecting and treating wastewater while recycling valuable resources for golf course irrigation in the Carmel Bay region.

Treatment Technologies Used

The CAWD Wastewater Treatment Plant (WWTP) has a permitted capacity of 3.0 million gallons per day (MGD) of dry weather flow. Current average dry weather flow (ADWF) is approximately 1.1 MGD which represents 37% of the permitted capacity. Of the 1.1 MGD, approximately two-thirds are from CAWD customers, and the remaining one-third is from Pebble Beach Community Service District customers.

During large storm events the inflows can increase up to eight times the dry-weather rates. This requires the plant equipment and processes designed to manage large hydraulic loads during the winter months.

Influent Pumping

The purpose of influent pumping is to lift the incoming untreated sewage from the terminus of the interceptor sewers up and into the headworks from where the sewage can flow by gravity through the other treatment processes. Approximately 97% of the influent sewage is pumped at the influent pump station; the remaining 3% is discharged directly into the headworks from the Calle La Cruz pump station in the Carmel Meadows subdivision.

During power outages, a dual standby generator system automatically provides backup power to all four influent pumps. There is always at least a 7-day supply of fuel onsite to power the standby generator.

Headworks

The headworks structure, together with the adjacent influent manhole, contains all the pretreatment processes of the plant. Unit processes located within the headworks are influent flow measuring, automatic bar screening, grit removal and washing.

The automatic bar screen removes rags and other large solids from the raw sewage and into a hopper which stores the screenings until they are removed and disposed of at the landfill.

Grit (i.e., sand, coffee grounds, other inorganic materials) is removed from the raw sewage by means of settling in an agitated tank. The agitation keeps the lighter organic solids in suspension and allows the heavier solids to drop out and be removed by pumping the contents from the bottom of the tank into a grit classifier and washer. The grit washer further separates the heavier grit particles from the lighter organic matter and the grit is then disposed of into a bin for disposal at the landfill.

Primary Sedimentation Tanks

The Primary Clari-Thickener tanks remove the majority of suspended solids from the wastewater by gravity settling. CAWD has two primary Clari-Thickener tanks for redundancy. The Clari-Thickener combines the feature of a Primary clarifier for removing settleable solids and floating matter (scum) and a thickening well for concentrating sludge prior to withdrawal for further treatment. Each tank has a mechanical scraper which rotates around the sloping bottom and pushes settled sludge to a sludge thickening zone and a sludge sump. Sludge is withdrawn from the tanks and is transported to the anaerobic digestion tanks. Floating matter is mechanically skimmed into collecting hoppers and is also transported to the anaerobic digestion tanks.

The primary sedimentation process is a physical process utilizing gravitational forces. Settleable and suspended solids, which are the major components of sludge and are heavier than water, settle out of the sewage along with any grit carryover from the headworks. Scum, which is lighter than water, floats to the surface and is removed by skimming. Approximately 60 to 65 percent of the suspended solids will be removed by gravitational forces as part of primary sedimentation.

Effluent from the primary sedimentation tanks overflows into double sided circumferential launders and then flows into either the primary equalization system or the aeration basins.

Primary Equalization

The flow equalization basins are designed to reduce flow to the treatment plant during daytime periods of high influent flow. Wastewater stored in the flow equalization basins is reintroduced into the normal wastewater stream at the option of the operator in order to maintain operation of the Reclamation facility when influent flows are low. This operation also ensures that influent flow can be prioritized for reclamation uses over discharge to the outfall.

The reintroduced flow is pumped back to the Headworks.

Diffusers are located in the basins to prevent stored wastewater from becoming septic.

Anoxic Selector

The Anoxic Selector mixes the return activated sludge (RAS) from the secondary clarifiers with effluent from the primary clarifiers and equally distributes the combined flow to Aeration Basins No. 4, 5, and 6.

Aeration (Biological Activated Sludge Process)

The aeration structures (basins) are designed to promote the growth of helpful bacteria organisms which consume the nutrients in the sewage. This is called the "activated sludge" process. By injecting substantial amounts of oxygenated air, these bacteria thrive and consume the biochemical oxygen demand, ammonia, carbohydrates, fats, along with other materials in the sewage and convert it into bacterial mass or "sludge" for removal in the Secondary Sedimentation Tanks.

The aeration structures can hold about 1.15 million gallons total divided into three separate basins. The helpful bacteria population is maintained in the basins by returning a portion of the sludge separated out of the water downstream in the Secondary Sedimentation Tanks back to the front of the Aeration Basins. This allows the helpful bacteria to live out their life cycle in the treatment process, all the while providing a beneficial service to the treatment process.

CAWD utilizes A2O process which creates different zones in the aeration basins, some with oxygen (aerobic), and some without oxygen (anoxic/anaerobic). The different zones allow for selecting the types of bacteria that are the most beneficial and to enhance the nitrification process.

Aeration in each basin is accomplished by air blowers feeding fine bubble diffusers at the bottom of each basin. Air flow is regulated by automatic dissolved oxygen (DO) control systems.

Mixed Liquor Distribution Structure

The Mixed Liquor Distribution Structure receives and combines the flows exiting the Aeration Basins. Combined flow is then gravity-fed to the Secondary Clarifiers. Two gates are used to control flow to each of the two Secondary Clarifiers.

Secondary Sedimentation Tanks

The Secondary Sedimentation Tanks are similar to the Primary Sedimentation Tanks except they are designed to remove lighter suspended solids. There are two tanks, each equipped with rotating mechanical sludge and scum collectors. The effluent from the Aeration Basins enters each tank through the bottom, rises up through the center column, and then is distributed into the sedimentation zone. Settled sludge is removed from the tank and clean water flows over weirs to the next step in the process (disinfection). The sludge is pumped back to the Aeration process to maintain the helpful microorganism population or wasted to the solid's treatment process. Scum is collected from the surface of the wastewater in each tank and returned to a sump in the Aeration Structure, from which it is then pumped to the solid's treatment process.

The clean water coming out of the Secondary Sedimentation Tanks is clear and has exceptionally low concentrations of bacteria and ammonia. Disinfection/Dechlorination is next and is the final treatment step before this water is sent to the Reclamation Facility or to the Ocean.

Secondary Effluent Diversion Structure

The Secondary Effluent Diversion Structure serves two purposes:

1. Aiding in downstream disinfection - Secondary flow enters the structure where an injection of liquid Sodium Hypochlorite and aqueous ammonia is used for disinfection leading into the chlorine contact channels at the Chlorination Building. When ammonia is introduced under the appropriate conditions, it reacts with hypochlorous acid to produce monochloramine. Monochloramine is used as a disinfectant rather than free chlorine because free chlorine is

detrimental to the Reverse Osmosis membranes at the Reclamation Facility. The amount of chlorine and ammonia required to produce monochloramine is based on the ideal weight ratio of 5:1. The desired ratio is controlled, monitored, and driven by programmable logic controllers located in the Hypochlorite/Sodium Bisulfite Building and the ammonia injection system at the Tertiary Facilities.

2. Flow Management – The Secondary Diversion Structure also receives the effluent flow from the Chlorination Building and either directs the flow to the holding basin at the Tertiary Building prior to reclamation or to the Outfall Building for ocean discharge.

Disinfection/Dechlorination

The last step to clean the water is disinfection/dechlorination. Disinfection is accomplished using liquid Sodium Hypochlorite (i.e., bleach) which kills bacteria and deactivates viruses and protozoa that may be harmful to human health. A small concentration of chlorine is maintained in the water for about 2 hours to make sure all of the harmful pathogens are killed or deactivated. The residual chlorine is then removed using liquid sodium bisulfite. At this point, the water is safe to send out to the ocean, or it is sent to the Reclamation Facility for further treatment to allow the water to be reused for irrigating golf courses in Pebble Beach.

Treated Water Pump Station and Ocean Outfall

The treated water is pumped to Carmel Bay, or it is treated further in the Reclamation Facility and sent to Pebble Beach golf courses. The water that is pumped to the ocean the majority of the year is concentrated brine which is the water left after treatment through the Reverse Osmosis (RO) system in the Reclamation Facility. The RO system removes dissolved solids (i.e., salts), which are collected in the brine. This brine is then pumped to the ocean. The salt content of the brine is lower than the salt content in the ocean and so there are no detrimental effects associated with the brine. During winter storms, when flows increase, a portion of the treated water is not sent to the Reclamation Facility and goes directly out of the outfall.

A pipeline carries the treated water or brine to the ocean. The existing ocean outfall is a 24-inch diameter, concrete encased pipe with 10 diffuser ports along the pipe. Each port has a rubber “duckbill” type valve to prevent debris from entering the outfall pipe during periods of low flow. The diffusers are designed to quickly disperse the treated water into the receiving water so that there is no environmental degradation around the outfall.

Solids Treatment and Disposal

There are several individual processes that are utilized to manage and treat the solids generated from the wastewater treatment process. These are: Sludge Thickening, Anaerobic Digestion, and Dewatering.

Sludge Thickening

The lighter sludge generated by the Secondary Sedimentation Tanks and the Microfiltration Membranes (Reclamation) are sent to the Dissolved Air Flotation Sludge Thickener to thicken the sludge before sending it to the Anaerobic Digesters.

Thickening is achieved by adding fine air bubbles into a tank containing the light sludge. The air lifts the sludge particles to the surface so they can coalesce at the surface and be skimmed off in a more concentrated/thick state. This thicker sludge that is collected is sent to the Anaerobic Digesters. The liquid that the solids are separated from is returned to the Headworks to be treated again through the plant.

This is not required for the sludge from the Primary Sedimentation Tanks which is already thick enough to send straight to the digesters.

Anaerobic Digestion

The solids treatment process takes sludge and other solids and places them in an anaerobic digester where the sludge is kept at about 95 degrees and anaerobic bacteria are utilized to stabilize the sludge and remove pathogens. The detention time in the anaerobic digesters is maintained at around 20 days or more.

A byproduct of the anaerobic digestion process is methane gas. CAWD uses the methane produced to generate electricity using two microturbines. The microturbines can produce about 15% of the power demand required by the wastewater treatment plant (not including the Reclamation Facility).

After the solids have been stabilized sufficiently by the digestion process the solids are held in a holding tank before they are sent to the dewatering equipment.

Dewatering and Land Application

Dewatering is a physical/mechanical process used to reduce the moisture in digested sludge (biosolids). There are reasons for dewatering sludge. In general, it is more economical to dispose of the dewatered sludge than it is to pump or haul liquid sludge to disposal sites because by reducing the moisture content, the sludge volume and weight are reduced.

The CAWD plant uses a belt filter press or a screw press to dewater the digested sludge. This equipment presses out the moisture from the sludge to create a dry material that is essentially dirt that can be land applied.

The dewatered sludge is hauled by truck to Kern County where it is used as a compost amendment for nonfood crops.

Reclamation Plant

Overview

On an average day about 90% of the water that comes into the CAWD wastewater treatment plant is reclaimed and sent to Pebble Beach golf courses for irrigation. CAWD owns the Reclamation Treatment Facility which is a part of a larger project including storage and conveyance infrastructure that was created in partnership with the Pebble Beach Community Services District (PBCSD), and the Monterey Peninsula Water Management District (MPWMD). Collectively the Reclamation Project offsets about 1,000-acre feet per year of potable water that would otherwise be drawn from the Carmel River aquifer. This 1,000-acre feet per year is an important part of the water supply portfolio for the greater Monterey Peninsula, Seaside, and Carmel Area. For reference, the total annual water taken from the Carmel River is about 3,000-acre feet per year.

The original reclamation plant, constructed in 1994, consisted of a large storage basin, and a sand filtration process to remove fine particulates from the water to meet California recycled water treatment requirements.

In 2008 a more advanced treatment facility was added to treat the water to an even higher quality. The new facility contains microfiltration (MF) and reverse osmosis (RO) membranes to filter out dissolved ions (salts) from the water.

The MF/RO system has a capacity to produce 1.8 million gallons per day (MGD) of recycled wastewater. Based on current average flows, the average output of reclaimed water is about 1.0 MGD.

Pretreatment of Secondary Effluent

Secondary effluent is diverted by gravity from the secondary process flow stream to the tertiary plant flow equalization basin. The flow equalization basin provides adequate storage of secondary effluent to allow the reclamation facilities to operate at full capacity during nighttime periods of low secondary effluent flow. The tertiary facilities

Tertiary influent is pumped to the coagulant rapid mix chamber for addition of Cerium Chloride for phosphorus and colloidal solids removal. The coagulated flow is then routed to one or two two-stage flocculation chambers. The flocculated flow is divided to flow through four continuous backwash filters. Feed water is passed upwards through the sand bed, exiting from the top of the filter media as clean water. While at the same time, sand is continuously moved from the bottom of the filter bed, cleaned by air scouring, and returned to the top of the filter.

Following filtration, the clean water is pumped through strainers and into the Microfiltration system.

Microfiltration (MF)

Microfiltration membranes filter exceedingly small particles out of the water (smaller than the diameter of a human hair). The membranes can physically block individual microorganisms such as bacteria from passing through.

Due to the small pore sizes in the membranes the microfiltration membranes provide a slightly better product than traditional filters such as sand filters. Microfiltration provides pre-filtration prior to the water being sent to the Reverse Osmosis System to remove dissolved ions.

The microfiltration membranes are submerged in a basin that is filled with the treated water from the wastewater treatment plant. The water is pulled through thousands of small straw-like membranes with microscopic pores to filter the water. The dirty water is left in the basin to be backwashed and removed to the solid's treatment process in the wastewater treatment plant.

Reverse Osmosis (RO)

Reverse osmosis membranes physically remove even smaller particles than MF. The RO membranes remove ions at the atomic level (i.e., ions dissolved in the water). This also provides physical removal of viruses in addition to further removal of bacteria in the water.

The water that does not pass through the RO membranes becomes a concentrated brine that contains all of the dissolved ions, and cells that are rejected by the membranes. This brine is disinfected and dechlorinated to deactivate and kill viruses and bacteria before the water is sent to the ocean outfall for disposal.

Disinfection

Similar to drinking water the state requires that recycled water be disinfected prior to distribution, and that a chlorine residual be maintained in the distribution system to mitigate regrowth of harmful bacteria in the piping.

CAWD utilizes sodium hypochlorite and aqueous ammonia to create chloramines for disinfection and to maintain a disinfectant residual in the distribution system. Chloramines are also commonly used in drinking water systems because they have less carcinogen developing properties than free chlorine.

Conveyance

CAWD pumps the water from the treatment plant to Pebble Beach using vertical turbine pumps. The water must travel about 5 miles and up in elevation about 250 feet to get to the Pebble Beach storage infrastructure.

Targeted Removals of Main Pollutants

- BOD target removal 90% of influent average BOD per month.
- TSS target removal 90% of influent average TSS per month.

Overview of Any Liquid or Solid Waste Produced

- Liquids see Section C Flow Evaluation
- Solid Waste see Section G Sludge Management

Upgrades Since the 2014 Permit was Issued

New Structures:

- Anaerobic Digester #2 -450,000 gallons.
- Control Building for Anaerobic Digester #2 with future space for cogeneration equipment.
- Ferric Chloride Storage and Dosing for Sulfide control in digesters.
- Sodium Hypochlorite/Sodium Bisulfite storage 9,000 gallons of each product, new chemical dosing pumps (with redundancy).
- Storm water pump station to retain all storm water collected on facility site and treated in the plant flow stream.
- Waste gas burner to meet the stricter clean air requirements.
- 2023 new sludge holding tank, replacement of 1938 sludge digester. Installed new sludge mixing system in new sludge holding tank and instrumentation.

Existing Structures that Received Upgrades

- Dewatering Building received new screw-press and polymer systems.
- Blower Building received new energy blower and air diffuser membranes.
- Dissolved Air Floatation Thickener received new solids collector and drive, sludge pumps, and air compression systems.
- Operations Building received new Motor Control Center, Programmable Logical (PLC) Computer and Supervisory Control and Data Acquisition System (SCADA).
- Fresh Water System (#1 water system) Air Gap System with dual re-pressurization pumps.
- Return Activated Sludge (RAS)/Waste Activated Sludge (WAS) building received new Motor Control Center, Programmable Logical (PLC) Computer and Supervisory Control and Data Acquisition System (SCADA).
- The Chlorination Building removed all Chlorine (CL₂) gas system.
- Phase two completion 2023 included:
 - Influent pump station: 4 new influent pumps and Motor Control Center for building.

- Headworks equipment: replaced influent flow meter, installed new slide gates, new grit collector drive, new grit washer, installed new influent screens and rag compactor. New Motor Control Center and instrumentation.
- Chlorination/Dechlorination Building: installed new Motor Control Center and Programable Logic Controller. New chlorine analyzers and sample pumps.
- Final Effluent Pump Station: replaced Motor Control Center and Programable Logic Controller. Replaced isolation valves on all pumps in station. Replaced effluent flow meter. Installed mixing system in wet well to prevent solids building up on the floor of the station.
- Replaced main electrical feeds to all areas of Motor Control Center replacement including new power to Laboratory during power failures.

Section A: Data Tables and Graphs

TABULAR SUMMARY OF 2023 RECLAMATION NPDES REPORTABLE DATA

Month	Reclaimed Flows		COD ₅	Total Suspended Solids	Turbidity	
	Monthly Total Flow MG	Daily Avg MGD	5-Day mg/l	Total Residue mg/l	Metered NTU's	
					Avg	Max
Jan	23.155	1.007	0.90	0.03	0.02	0.03
Feb	2.262	0.206	1.60	0.10	0.03	0.03
Mar	0.842	0.168	1.00	0.20	0.06	0.07
Apr	24.024	0.961	1.14	0.05	0.02	0.04
May	33.644	1.085	0.76	0.06	0.02	0.04
Jun	31.829	1.061	1.16	0.13	0.02	0.04
Jul	33.105	1.033	1.42	0.17	0.02	0.04
Aug	32.645	1.033	2.12	0.06	0.02	0.02
Sep	30.048	0.991	1.73	0.04	0.02	0.02
Oct	29.379	0.907	1.88	0.05	0.02	0.03
Nov	28.608	0.983	1.30	0.01	0.02	0.03
Dec	29.423	1.162	1.23	0.06	0.02	0.03

Lab Data 1

Month	CL2 Residual		pH	Total Coliforms	Sett. Solids	TDS
	Metered mg/l		Grab Daily Units	mpn / 100 ml	ml/l	mg/l
	Min	Max				
Jan	6.66	9.38	6.9	<1.0	<0.1	242
Feb	7.10	9.43	7.7	<1.0	<0.1	474
Mar	6.48	7.72	7.1	<1.0	<0.1	244
Apr	7.32	8.58	7.2	<1.0	<0.1	214
May	7.73	9.03	7.1	<1.0	<0.1	291
Jun	7.30	9.06	7.2	<1.0	<0.1	222
Jul	7.39	8.82	7.1	<1.0	<0.1	248
Aug	7.18	8.86	7.1	<1.0	<0.1	270
Sep	7.54	8.88	7.1	<1.0	<0.1	240
Oct	7.25	8.57	7.1	<1.0	<0.1	231
Nov	7.42	9.27	7.1	2.4	<0.1	242
Dec	7.12	9.01	7.0	<1.0	<0.1	187

Lab Data 2

Reclamation Flow 2023

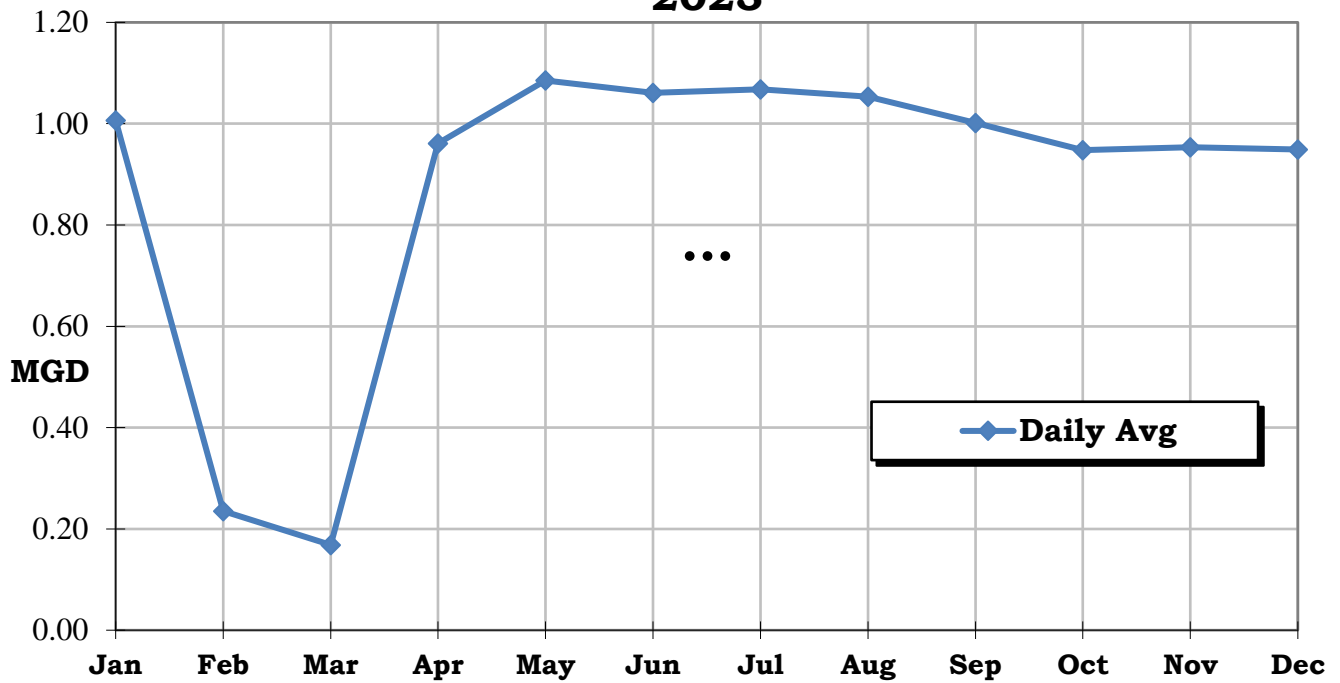

Graph 1

Reclamation CBOD 2023

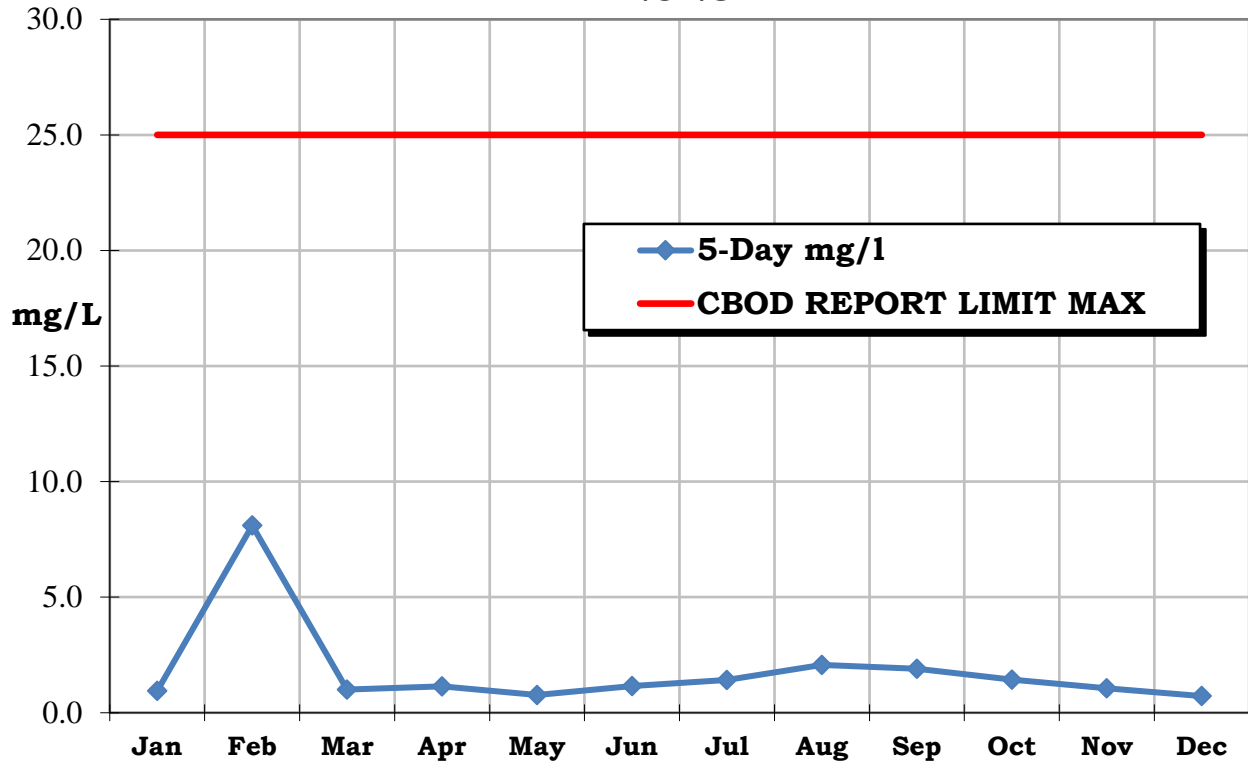

Graph 2

Reclamation T.S.S. 2023

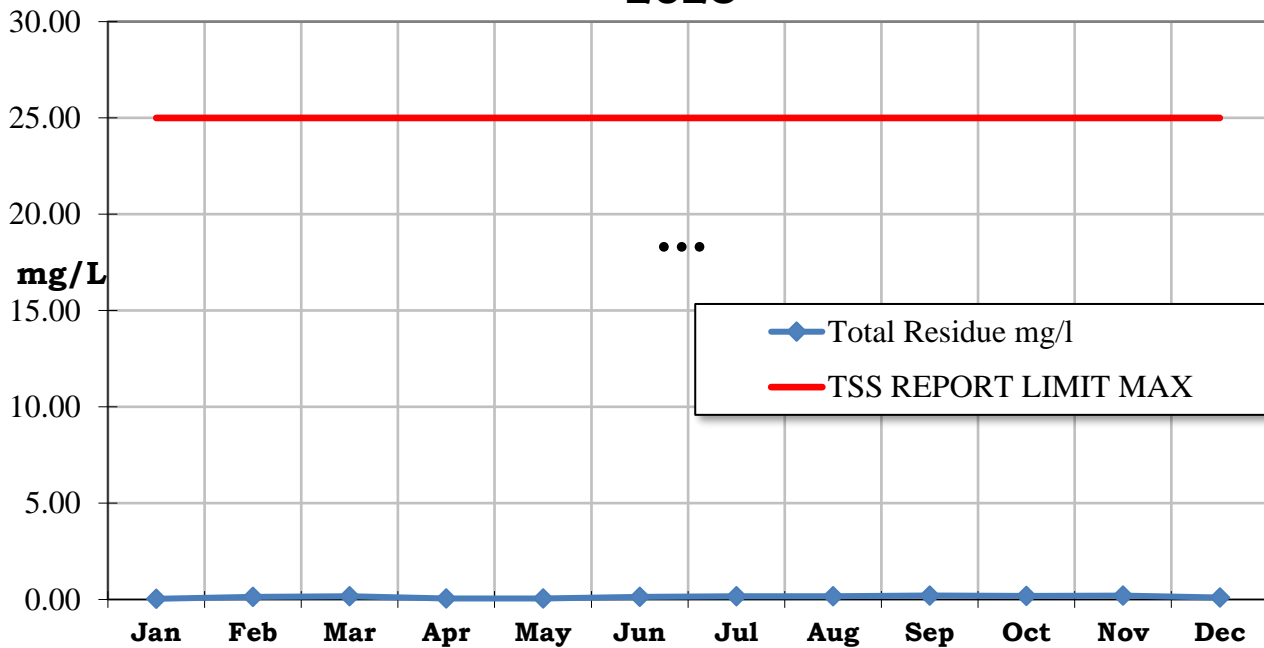

Graph 3

Reclamation Settleable Solids 2023

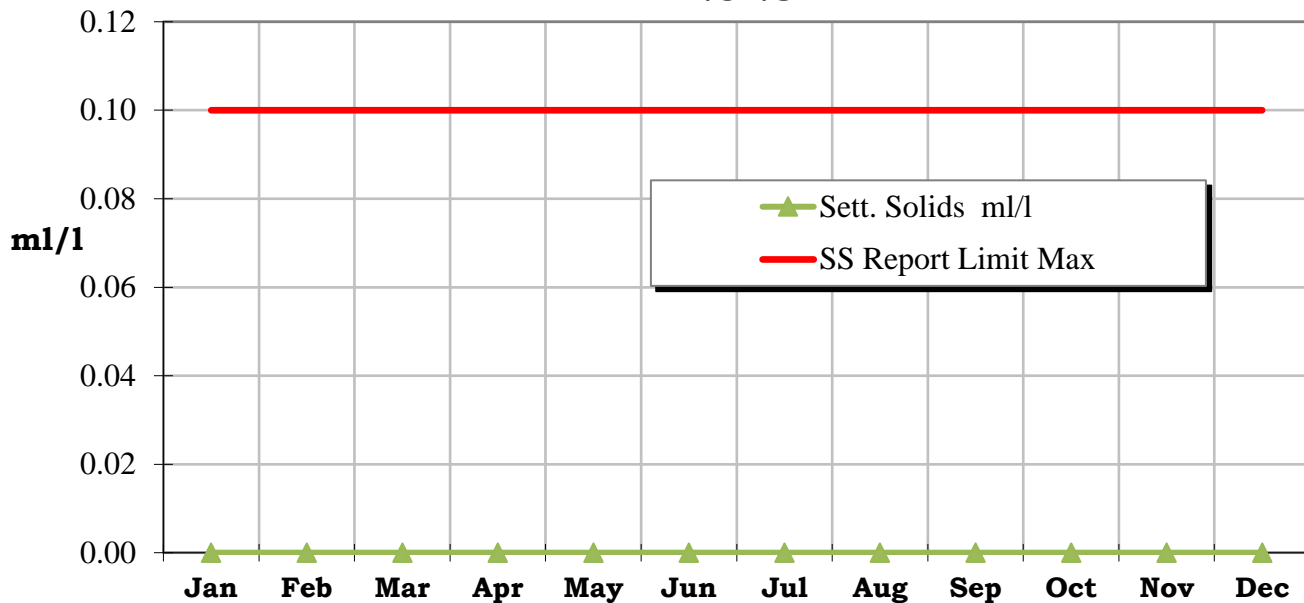

Graph 4

Reclamation Chlorine Residual 2023

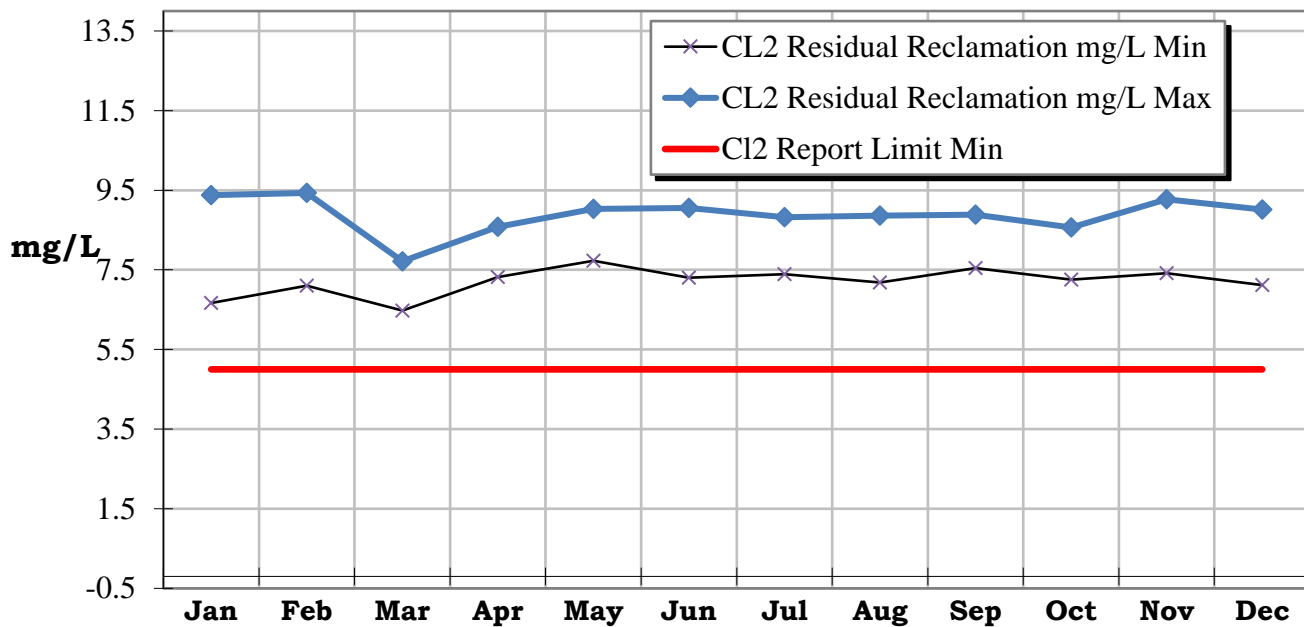

Graph 5

Reclamation Effluent Turbidity 2023

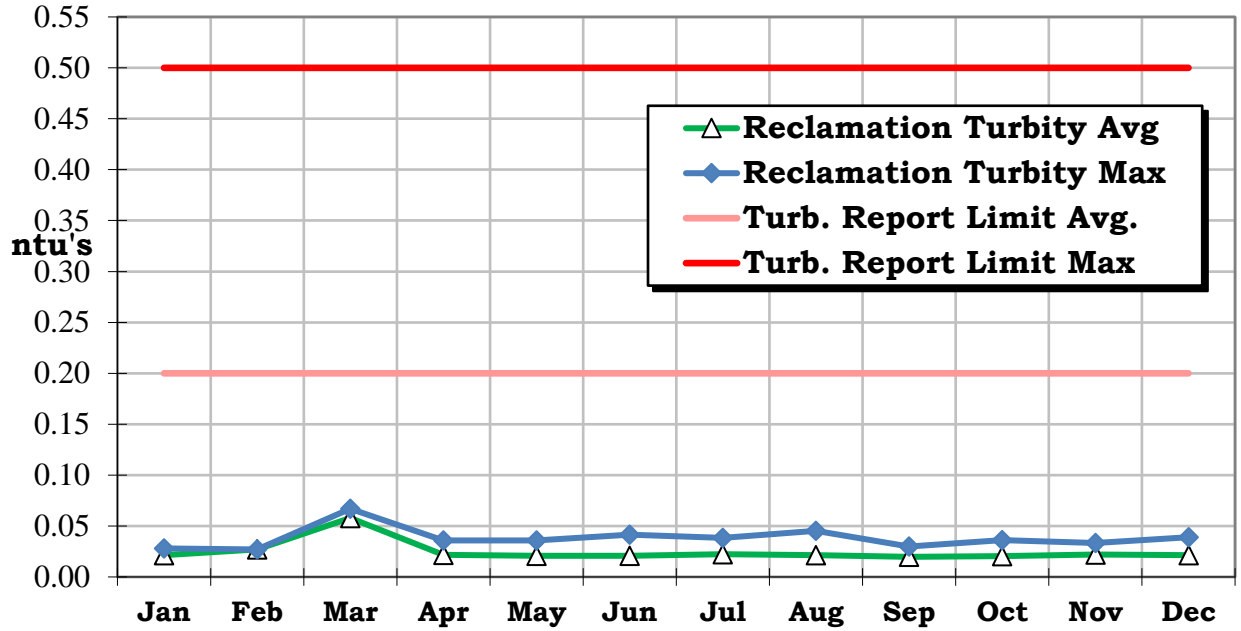

Graph 6

Reclamation Effluent pH 2023

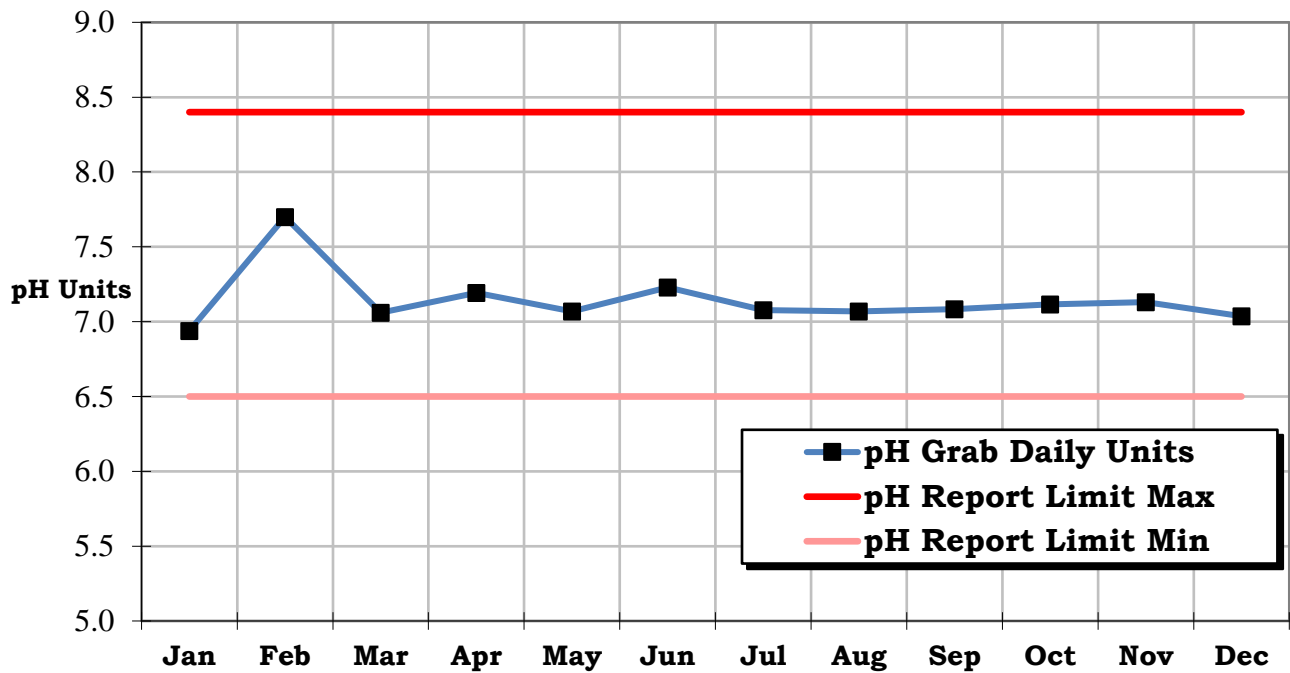

Graph 7

Reclamation Total Coliform Monthly Maximum 2023

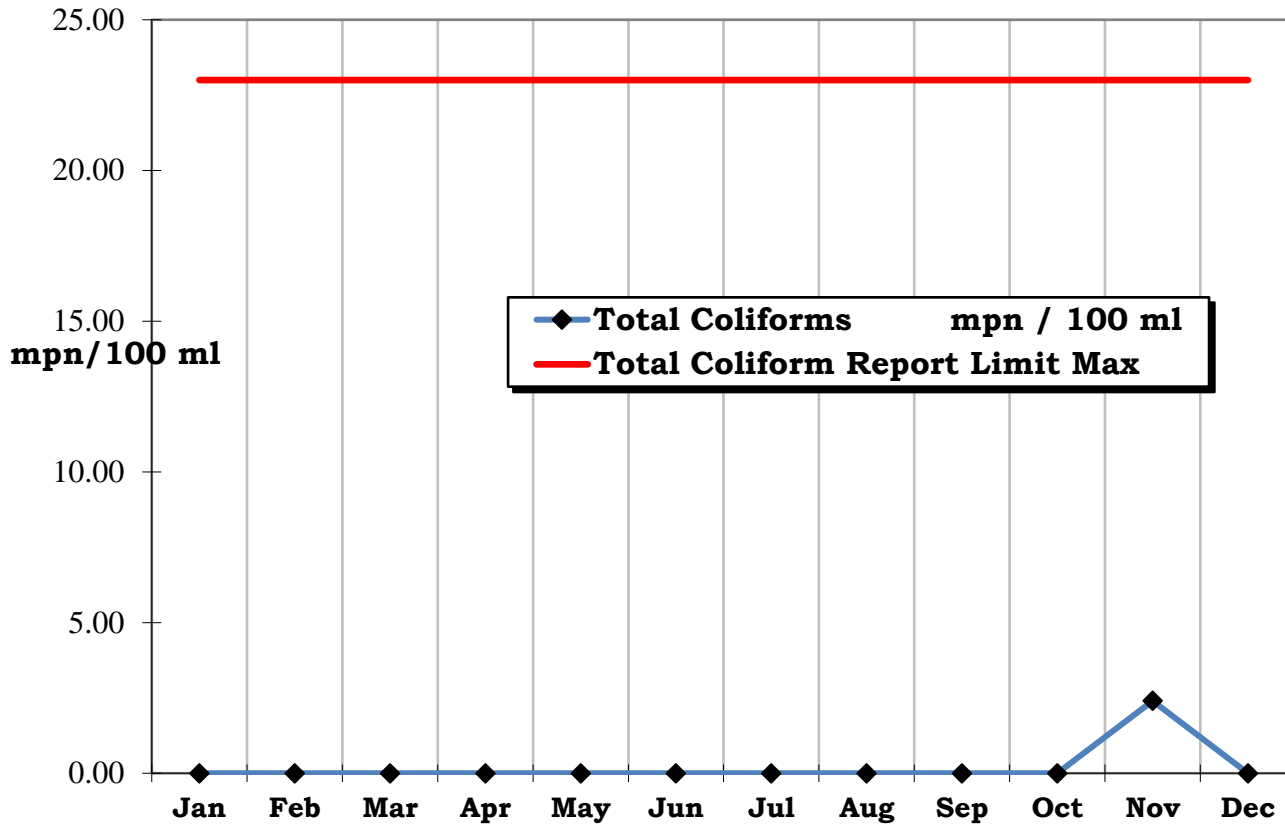

Graph 8

Section B: Compliance and Performance

- Treatment facility performance through percent removal of main pollutants.
 - CBOD percent removal (2023 annual average) was 99.6%
 - TSS percent removal (2023 annual average) was 99.9%
 - Coliform inactivation for 2023 was 99.9%
 - Settleable Solids percent removal (2023 annual average) was 99.9%

- Discussion of the previous year’s compliance record.

Carmel Area Wastewater District (CAWD) had no incidents of noncompliance for the year 2023 for WDR order No. 93-72.

- Any nuisance conditions or system problems.
 - None at this time.

For Facilities That Measure Groundwater

This Facility does not have requirements to perform groundwater measurements – Not applicable.

Section C: Flow Evaluation

2021	Max Monthly Daily Flow	Monthly Total
January	1.220	27.456
February	1.191	30.843
March	1.150	13.835
April	1.142	30.749
May	1.211	32.439
June	1.133	31.322
July	1.234	32.799
August	1.172	32.334
September	1.103	28.143
October	1.185	29.200
November	1.130	29.850
December	1.568	37.845
Total annual flow		356.815

Flow Data 1

2022	Max Monthly Daily Flow	Monthly Total
January	1.518	25.497
February	1.121	22.463
March	1.198	27.006
April	1.099	25.631
May	1.168	31.153
June	1.150	30.014
July	1.177	32.026
August	1.220	32.014
September	1.228	29.721
October	1.065	28.117
November	1.243	29.480
December	1.313	36.035
Total annual flow		349.157

Flow Data 2

Carmel Area Wastewater District
 Tertiary WDR Order 93-72 Annual Report 2023

2023	Max Monthly Daily Flow	Monthly Total
January	1.615	23.155
February	0.235	2.262
March	0.203	0.842
April	1.195	24.024
May	1.200	33.644
June	1.417	31.829
July	1.296	33.105
August	1.184	32.645
September	1.195	30.048
October	1.083	29.379
November	1.169	28.608
December	1.196	29.423
Total annual flow		298.964

Flow Data 3

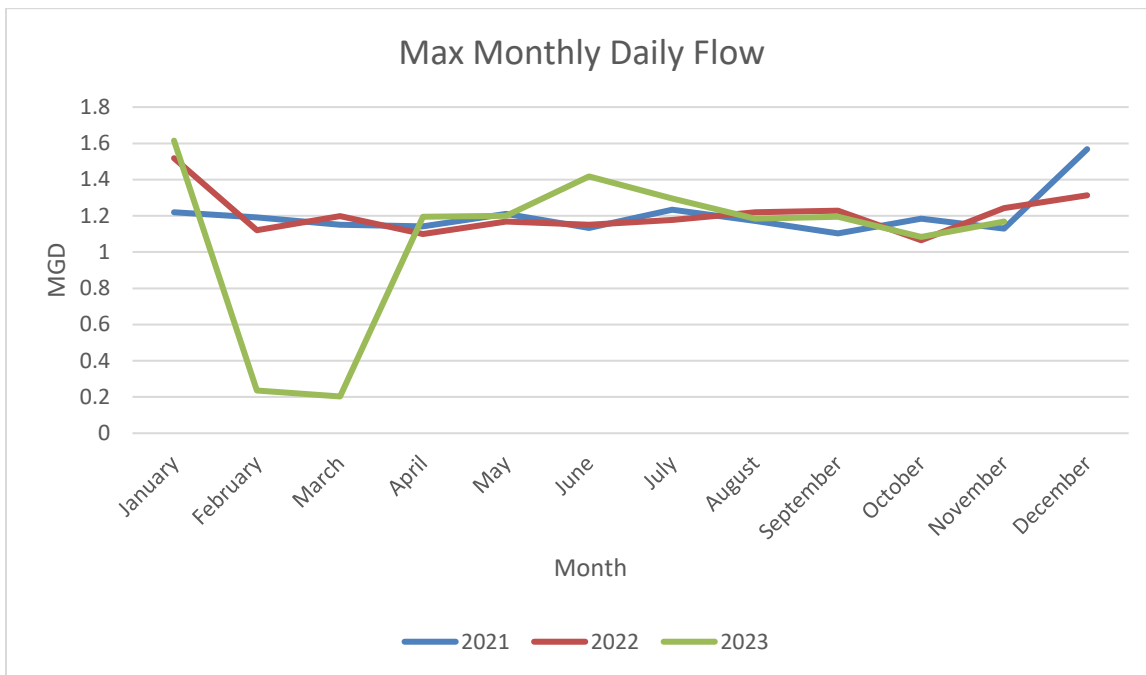

Graph 8

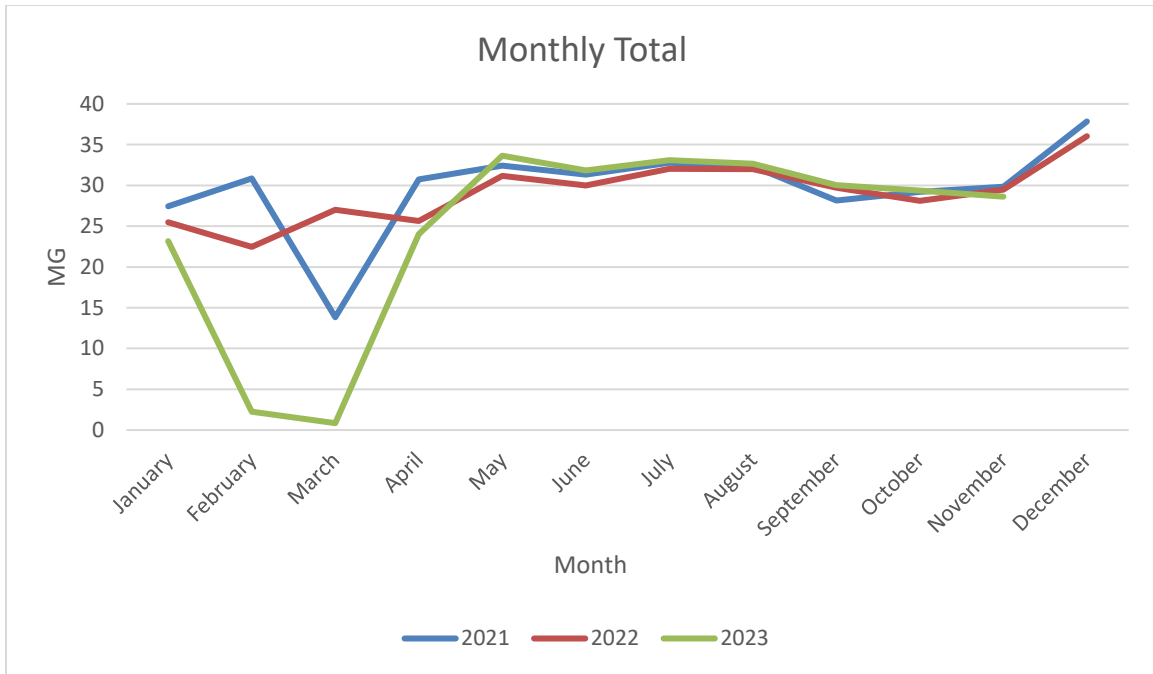

Graph 9

Section D: Operator Certification

Name	Operations Position	SWRCB Certification Level Maintained	License No.
Edward Waggoner	Operations Superintendent	V	4011
Kevin Young	Operations Supervisor	V	9660
Christian Schmidt	Senior Operator	III	28643
Chris Dixon	Senior Operator	III	40697
Michael Hooks	Senior Operator	III	41183
Michael Garrison	Operator II	III	10674
Charles DayEngel	Operator II	II	41894
Rommel Lopez	OIT	OIT	N/A

Section E: Operation and Maintenance

The Carmel Area Wastewater District's Reclamation Operation and Maintenance Manual was first written and submitted by the design engineers to the district on 12 August 1994 following a review and comment period. Corrections/amendments were made, and the last version of the Tertiary Operations and Maintenance Manual was submitted to the Carmel Area Wastewater District on 14 March 1995

The Tertiary Operations and Maintenance Manual was updated in 2007 as part of the Micro Filtration Reverse Osmosis (MF RO) Project. This was done by a joint effort with the Pebble Beach Community Service District.

The Reclamation Operations and Maintenance Manual, as submitted to the district by the design engineer, exists, by contract, as a hardbound copy as well as in an electric version such that Carmel Area Wastewater District Operations/Maintenance/Lab staff can modify procedures/drawings as required by experience/knowledge and system modifications. Thusly modifications occur on an on-going basis.

Section F: Laboratory Information

- 1 Monterey Bay Analytical Services
4 Justin Court, Suite D
Monterey, CA 93940
CA ELAP # 2385
- 2 Aquatic Bioassay & Consulting Laboratories, Inc.
29 North Olive Street
Ventura, CA 93001
CA ELAP# 1907
- 3 Carmel Area Wastewater District (CAWD)
PO Box 221842
Carmel, CA 93923
(831) 257-0432 -Phone
(831) 624-1478 -Fax
CA ELAP # 1804
- 4 Fruit Growers Laboratories (FGL)
853 Corporation St
San Luis Obispo, CA 93401
CA ELAP # 1573

Section G: Sludge Management

Sludge Management is managed by the Carmel Area Wastewater District NPDES permit CA0047996 and is addressed in that annual report. – Not Applicable.

Section H: Pretreatment

Pretreatment Management is managed by the Carmel Area Wastewater District NPDES permit CA0047996 and is addressed in that annual report. – Not Applicable.

Section I: Salt and Nutrient Management Plan

This facility does not need a salt and nutrient management plan. – Not Applicable.

Section J: Collection System Management Plan

The Collection System Management Plan is managed by the Carmel Area Wastewater District NPDES permit CA0047996 and is addressed in that annual report. – Not Applicable.

Section K: Mercury Seals

This facility does not use Mercury Seals – Not Applicable.

Section L: Figures

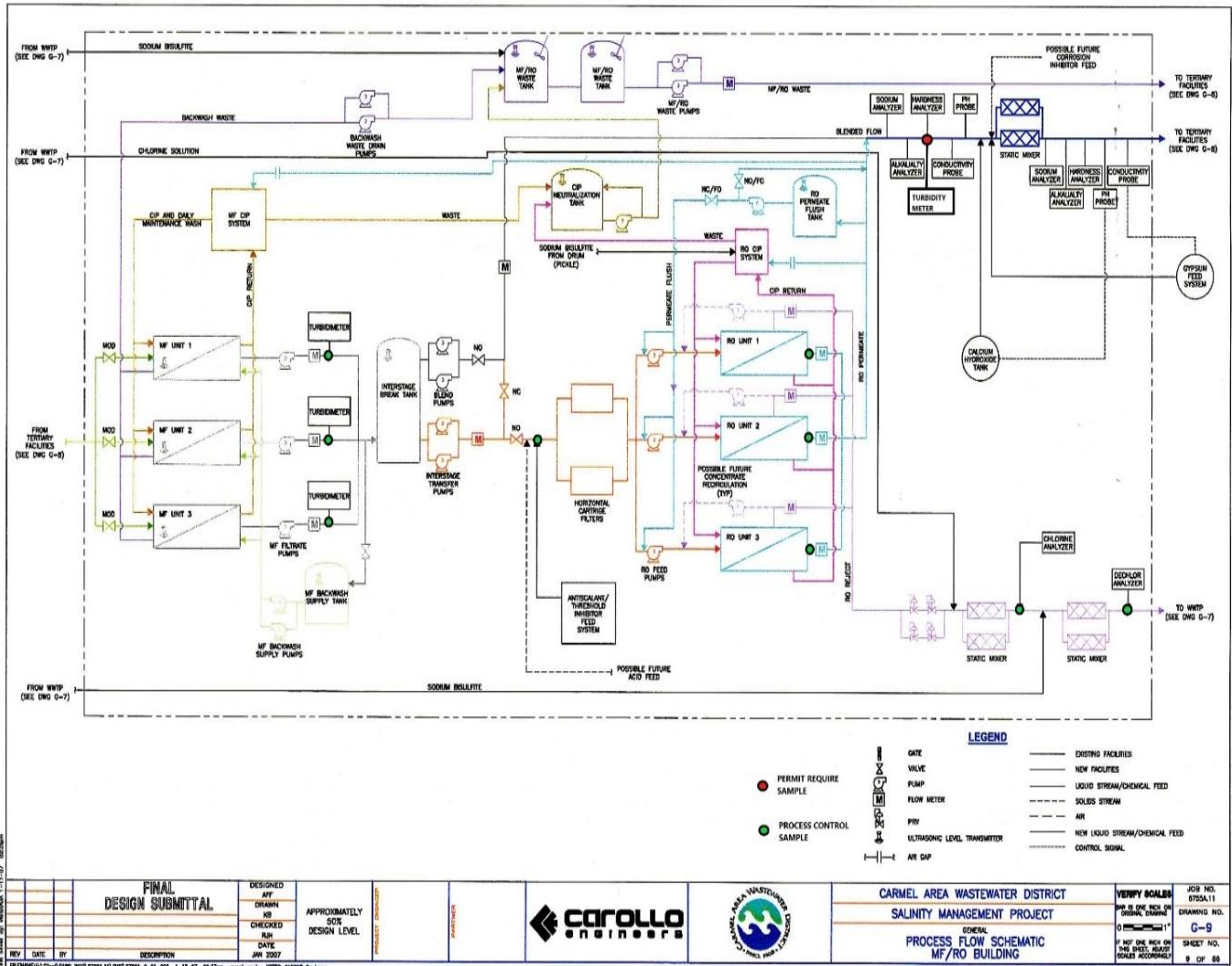

Fig 1

Carmel Area Wastewater District
Tertiary WDR Order 93-72 Annual Report 2023

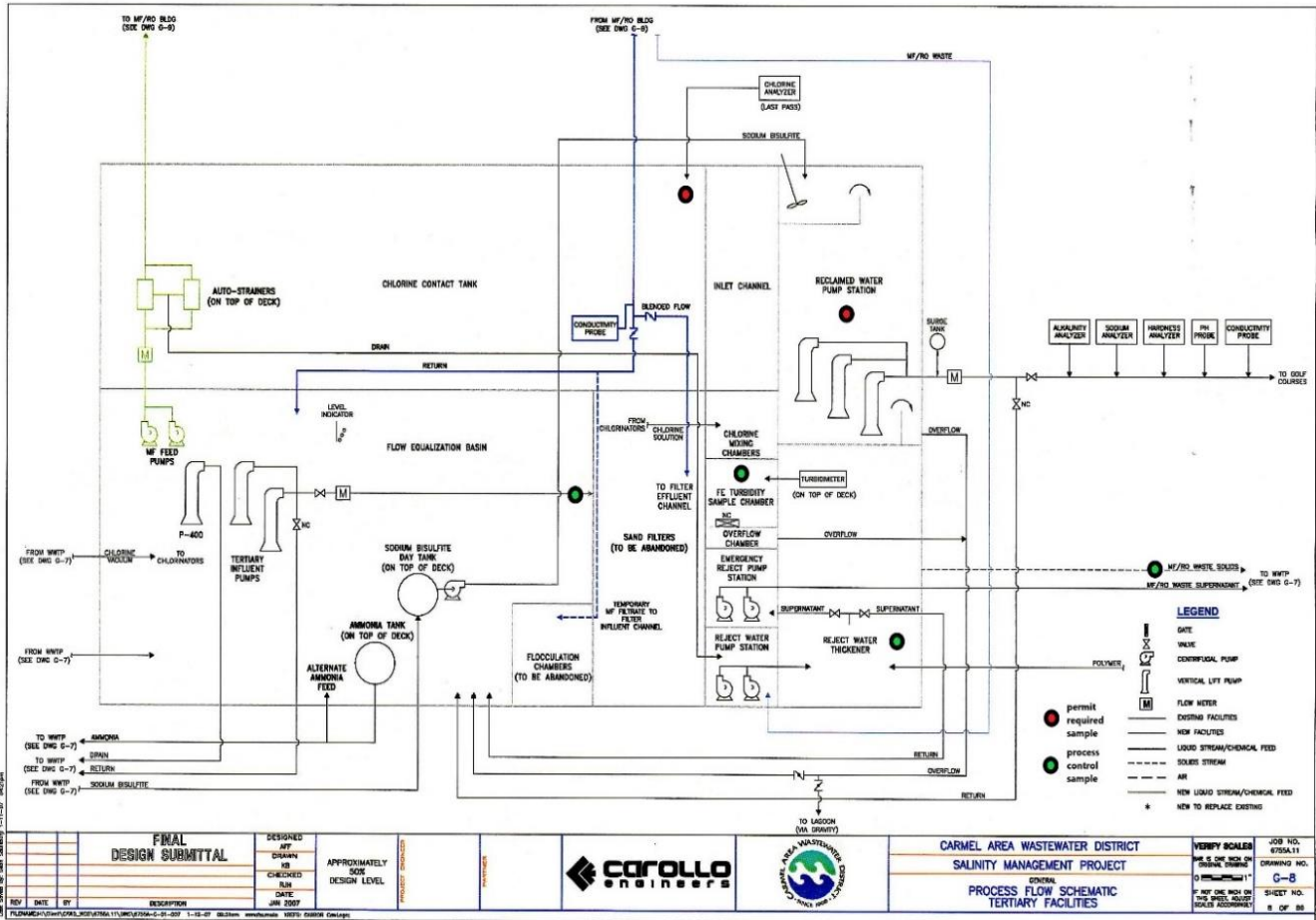

Fig 2



Fig 3

Lab Reports

This facility's Monitoring and Reporting Program requirements do not have specific annual monitoring.