



CDCI

SUMMARY OF FINDINGS
2023 Annual Outfall Underwater Survey
FINAL

October 2023

Prepared for
Carmel Area Wastewater District
3945 Rio Road
PO Box 221428
Carmel, CA 93922
Attn: Patrick Treanor, P.E.

Prepared under
Standard Form – Minor Services or Construction
Contract
Dated October 30, 2023

Prepared by
Crescent Diving & Contracting Inc.
135 Main Street
Crescent Mills, California 95934
Contact: Ron Null – Managing Partner

2023 Outfall Survey Summary Report



EXECUTIVE SUMMARY

On October 31, 2023 Crescent Diving & Contracting, Inc (CDCI) carried out the routine interval (annual) underwater survey of the Carmel Ocean Outfall on behalf of the Carmel Area Wastewater District (CAWD).

A general-visual “Level 1” survey of the offshore diffuser section and the lagoon crossing outfall supports as well as internal physical measurements to check for sediment and visual observations of discharge flow using dye introduced at the treatment plant. Video recordings with real-time audio narration of each task accompany this report.

The outfall diffuser risers, rubber ‘duckbill’ style backflow prevention valves, outfall terminus blind flange were found to be in overall “satisfactory” to “good” condition.

Internal sounding measurements were taken at four (4) selected diffuser port locations to detect any deposition accumulation within the outfall pipe. When compared to the previous year findings (2022), minimal discernable increase was detected.

Using dye introduced to the stream by CAWD personnel to visually enhance the discharge characteristics, all ten diffusers were observed under normal flow conditions. CDCI observed no signs of obstruction, damage, or significant defects in the rubber check valves during flow.

INTRODUCTION

CAWD retained CDCI under a fixed-sum (not to exceed) purchase order agreement to perform the routine (annual) survey of the underwater portions of the wastewater conveyance pipeline outfall.

CDCI has performed the annual survey for the past several years, and thus we are sensitive to detecting any subtle changes from previous observations. For the 2023 survey, as continuity the survey divers were the same personnel as the preceding year (2022).

SURVEY -- Offshore Diffuser Section:

On October 31, 2023 (Tuesday) an OSHA-compliant three (3) person diving crew was mobilized aboard the M/V “SIREN” from the Monterey Municipal Marina in accordance with applicable regulatory and CAWD purchase order requirements.

The surface-supplied diving mode (the standard of the commercial diving industry) has the advantages of two-way communication, real-time video monitoring and directing from the surface, as well as life support redundancies and dive profile controls.

As with the previous several years, for continuity the offshore portion of the 2023 survey, the surveying diver was CDCI Managing Partner, Ron Null. The field operations were coordinated with personnel at the treatment plant through CAWD Project Manager Patrick Treanor.

The scope of work included the following:



“Engineered Solutions for Water in the West”

- A general-visual, “level 1” survey of the ten outfall diffuser ports and outfall terminus blind-flange.
- Check for evidence of material deposition inside the outfall at selected diffuser locations by taking sounding measurements through the duckbill valve and riser
- Visually observe the discharge behavior characteristics of the ten diffusers under normal flow conditions, using added dye to enhance contrast

The offshore outfall is a 24-inch (internal) diameter pipeline, clad with what appears to be a concrete protective and ballast coating.

The survey focus area was the roughly 100LF diffuser section terminating at the end flange at STA 8+99. The diffuser section sits in approximately 40 to 45-feet of water depth, and the outfall end flange daylights horizontally out from what appears to be a concrete encasement.

The ten diffusers are identified with letter designations “A” through “J”, starting at the offshore end with “A” at STA 8+89 and moving inshore (upstream) at 10 ft spacing intervals to “J”.

Each of the ten diffusers consists of a riser that extends roughly one (1) foot vertically to a bolted flange connection. This short riser is also concrete clad up to the underside of the flange. Bolted to this flange is an inverted J-tube riser capped by a rubber duckbill check valve.

Each diffuser riser is 53 inches from the center of the bolted flange connection to the centerline elevation of the duckbill.

The reference drawings depict the diffusers as extending vertically out of the crown of the pipe and call out a horizontal offset of 15 degrees of the downstream flow direction for the duckbill valves. This 15-degree offset is shown as alternating with the odd duckbills at +15 and the even duckbills at -15 from the centerline of the pipe (Figure 1).

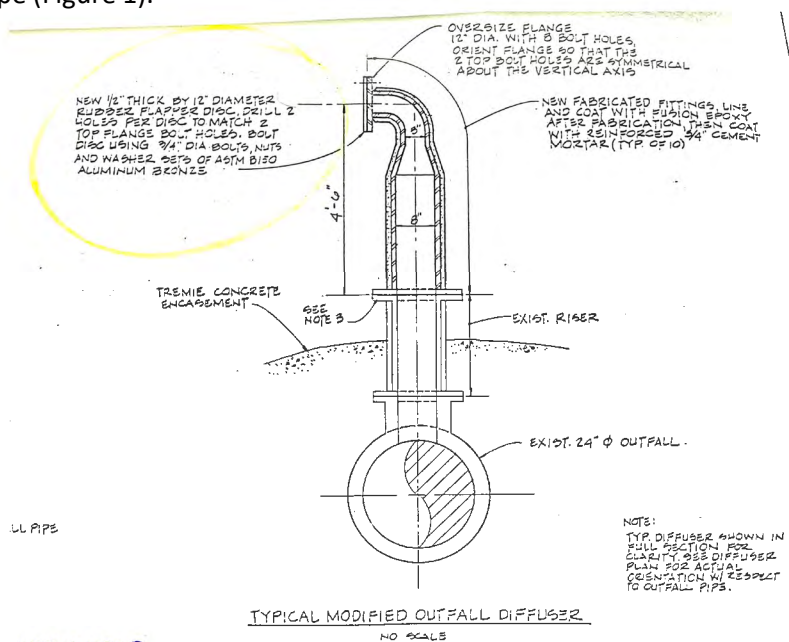

Figure 1 – Diffuser details in reference drawings



"Engineered Solutions for Water in the West"

FINDINGS -- Offshore Diffuser Section:

The general visual ("level 1") survey of all ten diffusers and backflow valves under almost slack flow was observed and recorded via the helmet-mounted video camera and audio feed. All diffuser/risers were found to be intact with no observable signs of damage or significant deterioration. Each of the duckbill check-valves were pliable.

The actual condition of several of the diffusers at time of the survey were observed to be off vertical by several degrees, or with the impression of "leaning". This lean does not appear to be uniform as if the prevailing ocean swell has acted to influence the risers towards the shoreline. Rather they are "leaning" in what appears to be random directions, both against the swell direction as well as with it.



Image 1 – Diffuser riser 'leaning' off vertical (2021 image)

The leaning risers are the inner five (5) or "F" through "J". Following close review of past survey findings, the lean of these five does not appear to have changed, thus it may be that the deflection was resultant from a single incident or possibly that they were installed this way at time of original construction.

Rather than the alternating 15-degree offset from the downstream alignment of the pipeline axis, the actual alignment was observed to be (again) almost random with the alignment(s) being in multiple compass directions.

All ten diffuser risers were observed to be solid when physically pushed by the diver. No damage was noted.

A visual flow analysis using dye introduced into the outflow from the Plant allowed confirmation of what appeared to be equal flows from each of the ten diffusers. The ten duckbill valves appear to be



"Engineered Solutions for Water in the West"

functioning as intended. The interior sealing surface of the rubber valves, or "lips" are clean and free from any marine fouling or observable deposits that would prevent full closure and full sealing contact when under a no-flow condition. With full closure contact, the migration of sediment from the ocean is prevented. Reference survey video file "2021_OutfallSurvey_DiffuserSection" from 10:07:40 to 10:07:50



Image 2 – Duckbill contact sealing surface during no-flow (2021 image)

At the time of the 2023 dye discharge, the incoming (high) tide was just peaking and reaching the slack period. Ocean conditions were light swell and calm surface. Observable dye was confined to the diffusers, with no leakage indications betrayed from any other areas of the diffuser section surveyed. No dye was observed escaping from any area inshore of the diffuser section, nor at the blind flange at the outfall end. The end flange appears to be solid with all fasteners in place and secure.

Both hard and soft marine growth fouling was observed on the outfall component exterior up to between 3 and 4 inches over a uniform coverage of approximately 80 percent of the surfaces. This coverage does not allow detailed inspection of the pipe and risers, however gross deformities indicating exterior damages should still be discernable.

Marine growth on the rubber duckbill valves was also up to 75% with a maximum thickness of as much as 3 inches. Due to the service flexing of the rubber valve material while under flow, the fouling of the rubber surfaces was almost exclusively soft growth composition, with some minor hard-growth comprised of small barnacles of less than 1/2-inch diameter of basal plate. The fouling on the rubber surfaces of the duckbills did not appear to inhibit their function. On the day of the survey, relatively heavy kelp growth was prevalent in the vicinity of the outfall.



"Engineered Solutions for Water in the West"



Image 3 – Discharge from Diffuser (typical)



Image 4 – Discharge from Diffuser (typical)



“Engineered Solutions for Water in the West”

Representative diffuser ports were measured internally to detect sediment build-up. The offshore most diffuser “A”, a middle area location at diffuser “E”, and the inshore diffuser “J” were sounded. A 1-inch diameter galvanized steel pipe fitted with a 90-degree elbow at the insertion end was introduced through the duckbill valve to allow vertical sounding measurement using a flexible fiberglass tape measure weighted with a 16-ounce spherical lead weight.



Image 5 – Diffuser sounding device

The distance of travel from the elevation of the duckbill to the contact at the invert of the pipe was measured and recorded. Using lessons learned from previous surveys the diver was able to ‘jig’ the lead ball up and down and interpret the density of the material contacted. Findings and observations are shown in Table 1.

Diffuser Location	2023	Previous				
	Sounding (ft)	2022	2021	2020	2019	2018
A	8.5 / 3-4” of soft, somewhat ‘fluffy’ material then hard and firm surface	8.5	8.5	8.5	8.1	8.0
B	N/A	8.4	N/A	8.6	7.9	N/A
C	N/A	N/A	N/A	8.3	8.1	8.0
D	8.5 / firm material “dull” no “ring” of sounding weight on impact	8.5	N/A	8.0	N/A	N/A
E	N/A	N/A	8.5	8.5	N/A	8.0
F	N/A	N/A	N/A	8.1	N/A	8.0
G	N/A	8.1	N/A	7.8	N/A	N/A
H	8.0 / soft feeling contact of sounding weight, then firm material underneath	N/A	N/A	7.8	8.1	N/A
I	N/A	N/A	N/A	8.1	8.0	N/A
J	8.0 / firm contact with invert (riser not vertical)	8.1	8.6	8.6	8.6	N/A

Table 1 – 2021 Diffuser Soundings and previous comparatives

Note that prior to the 2020 soundings a 1-inch hex nut was used as the sounding weight and was considerably lighter in weight than the lead used beginning in 2020. We determined that a heavier (lead) weight would give better tactile feedback into the interior deposited material. This heavier weight accounts for the differences in dimensions from previous soundings and using the heavier spherical lead weight enables the diver to be able to get a much more discernable feeling as to the density and behavior of the interior material.



"Engineered Solutions for Water in the West"

Consistent with the preceding three years (2020,21,22), the diver felt as if the material farther out towards the dead flow area under and beyond the last diffuser "A" was a softer and lighter density material, characterized by the diver as feeling "gelatinous" or "pudding-like" when tapped by the round lead sounding weight. Moving upstream, the material has a feedback consistency described as "softer, but less penetrable after the feeling of initial contact resistance", while the farther upstream material "thudded like wet sand". Finally, the upstream-most diffuser "J" had a distinct clunk livelier and closer to a "ring" that the diver believes was likely the actual invert pipe surface with little or no material over it to deaden the feel.

RECOMMENDATIONS – Offshore Diffuser Section:

Flange Hardware – While the majority of the hardware at the flanges of the a) end blind, b) riser base, and c) duckbill mounting were encrusted in marine fouling and not visibly observable, no indication of loose or missing fasteners were observed.

Replacement of the hardware as part of a preventative maintenance protocol may be readily accomplished. Cleaning and preparation for removal may be done while the outfall is 'live'. The change-out of the hardware can be also be accomplished without disturbing the flow by "hot swapping" as with any live pipeline using temporary clamps to allow a complete or partial exchange.

Rubber Duckbills – Each of the ten duckbill valves appeared to be functioning as intended. Closer examination of the condition of the material will require removal of the marine fouling. A random or selected duckbill could be removed and recovered for examination with only the shortest suspension of flow. A blind flange could be installed at the removal location, and if acceptable that would then reduce diffusing to 9 of 10 diffusers during examination on the surface.

Interior Sediment – While it is assumed by many to be able to use a camera inserted into the pipe through the diffusers to quantify the material, for a relatively small outfall such as the CAWD system the only way to be certain is to recover samples and physically measure. For the Carmel outfall during a hardware swap a representative J-tube riser could be removed and a hard probe and material sampling could be accomplished at random or designated locations.

Similarly, should it be determined that the flow is realizing backpressure consistent with excessive interior sediment accumulation the removal of the risers at the lower flange will allow access to enable either removal using direct suction methods, or the agitation back into suspension using an eduction recovery method released to the sea. This method is described in the 2020 survey summary report.

Alternatively, the blind flange capping the offshore end terminus could be removed and replaced with a new flange fitted with a smaller, clean-out port and flange. This cleanout could then be removed during flow and a scraper or stiff brush could then be run in the full 100LF by adding 10-ft extensions.

Following the conclusion of the offshore diffuser section survey, the vessel dropped out of the mooring and transited back to the marina. The diving equipment and video spread was offloaded from the vessel and onto the worktruck. The CDCI crew then traveled by road to meet CAWD Patrick Treanor at the access gate and setup to carry out the dive survey of the lagoon crossing section from the shore.



"Engineered Solutions for Water in the West"

SURVEY -- Lagoon Crossing Section:

The outfall crosses the approximate 100LF of lagoon and is supported on three (3) two-pile saddle type supports.

The pipe supports were originally installed each as a pair of steel pipe piles filled with concrete, with steel beams welded on top to create the cradle. In 2019, a repair treatment was prompted by an observed indication of a possible failure sequence of the steel cradle due to advanced corrosion. An initial response repair to arrest the failure sequence was carried out in January 2019.

The following month in February 2019, CDCI was contracted by the District to encapsulate the repair(s) to mitigate further advancement of corrosion and extend the service life. The pile caps and saddles, augmented with steel as part of the January repair, were formed and encapsulated in reinforced concrete.

Of the three supports, the eastern unit sits at the edge of the lagoon shoreline and has almost no exposed piles. The other two are farther out into the velocity channel and have roughly 10 to 12 feet of exposed pipe pile. The existing steel piles, now extending out from the concrete encapsulations were treated with a structural enhancement epoxy and woven fiber system. Additional soft reaction bracing, comprised of clamps, cables and turnbuckles were installed in an "X" starting under the concrete cap encapsulation and extending down to just above the floor of the lagoon.

The diver for the second part of the 2022 survey in the lagoon was experienced CDCI Tier 1 Diver, Chris Altman.

FINDINGS – Lagoon Crossing Section:

Consistent with the preceding year (2022), the inspecting Diver was again Chris Altman, who reported the concrete repair encapsulations remain in good condition at all three outfall support locations.

The soft reaction bracing is secure, without observable damage, and appear to be functioning as intended. The two-part clamps are all firmly in place, the cable clips are tight, and the turnbuckles remain snug in tension. The visible portions of the epoxy and woven fiber pile wrap appear to be in good condition and without observable damage, indicating that the upper portion(s) under the UV protective second sheathing wrap can be realistically assumed to be in good condition as well.



"Engineered Solutions for Water in the West"



Image 6 – Upper clamp-to-turnbuckle connection of soft reaction bracing (typical)



Image 7 – Lower epoxy and woven fiber wrap treatment with two-part clamp (typical)



"Engineered Solutions for Water in the West"



Image 8 – Interface of plastic UV protective wrap under concrete encapsulation (typical)

RECOMMENDATIONS – Lagoon Crossing Section:

No adverse findings were noted during the 2023 survey. It is recommended to continue to add the lagoon crossing section to the annual outfall survey to maintain monitoring of conditions.

The District may consider adding additional stainless steel banding material to secure the UV protective wrap material as part of a future maintenance application, however at the time of the 2022 survey no damage that would create urgency for this treatment was noted.

REFERENCES:

2023 Outfall Underwater Survey video files, accompanying this report:

- 1) 2023_OutfallSurvey_DiffuserSection
- 2) 2022_OutfallSurvey_LagoonSection

Carmel Area Wastewater District
Secondary NPDES R3-2014-0012
2023 Annual Report

California Regional Water Quality Control Board
Central Coast Region
895 Aerovista Place, Suite 101
San Luis Obispo, CA 93401

Submit this Self Monitoring Report to: centralcoast@waterboards.ca.gov

Document
Date: 1/30/2024

FACILITY NAME: Carmel Area Wastewater District Wastewater Treatment Plant

FACILITY ADDRESS: 26900 State Route One
Carmel, CA 93922

CONTACT PERSON: Edward Waggoner

JOB TITLE: Operations Superintendent

PHONE NUMBER: (831) 257-0437

EMAIL: waggoner@cawd.org

WDR ORDER (Permit) Number: R3-2014-0012

WQID NUMBER: 3 270101001

PERMITTED FLOW (see facility WDR Permit): 3,000,000 gpd

AVERAGE WASTEWATER FLOW (over monitoring period): 1,438,000* gpd

TYPE OF REPORT: Annual Semiannual Quarterly
 Monthly Other: _____

REPORTING PERIOD: 01/01/2023 TO 12/31/2023

MONITORING PERFORMED DURING THIS PERIOD (check all that apply):

- | | | |
|---|--|---|
| <input type="checkbox"/> Groundwater | <input type="checkbox"/> Lab Reports | <input type="checkbox"/> Recycled Water |
| <input checked="" type="checkbox"/> Treatment System Effluent | <input checked="" type="checkbox"/> Solids Disposal | <input type="checkbox"/> Disposal Area |
| <input checked="" type="checkbox"/> Treatment System Influent | <input checked="" type="checkbox"/> Water Supply | <input type="checkbox"/> Use Area |
| <input checked="" type="checkbox"/> Source Water Monitoring | <input checked="" type="checkbox"/> Other: <u>Cutfall Inspection</u> | |

Violation(s) during this monitoring period? YES NO

Parameter(s) in Violation: *Pursuant to Standard Provisions³ see footnote on next page, monitoring reports must contain date of violation, explanation of cause and corrective actions planned or taken to prevent recurrence. Please include parameter(s) and date(s) of violation in space provided below. If space is insufficient, include an independent discussion containing explanation of cause and corrective action within monitoring report.*

See Section B: Compliance and Performance

Discharger Comments:

*Influent Plant Flow, note CAWD has two separate discharge permits R3-2014-0012 for ocean discharge and #93-72 for reclamation discharge. Average GPD ocean discharge average was 618,000 GPD for 2023, and average daily reclamation discharge to golf course irrigation storage was 818,000 GPD for 2023.

Carmel Area Wastewater District
Secondary NPDES R3-2014-0012
2023 Annual Report

Submit this self-monitoring report to centralcoast@waterboards.ca.gov in searchable PDF format. Include attached cover sheet and signature page. DO NOT submit via US mail.

In accordance with the Standard Provisions and Reporting Requirements, I certify under penalty of law that this document and all attachments were prepared under my direction or supervision following a system designed to assure that qualified personnel properly gather and evaluate the information submitted. Based on my knowledge of the person(s) who manage the system, or those directly responsible for data gathering, the information submitted is, to the best of my knowledge and belief, true, accurate, and complete. I am aware that there are significant penalties for submitting false information, including the possibility of fine and imprisonment.

Print Name: Edward Waggoner Title: Operations Superintendent

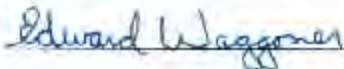
Signature:  Date: 01/30/2024

*All reports shall be signed by one of the following:

- a. For a corporation: by a principle executive officer of at least the level of vice president.
- b. For a partnership or sole proprietorship: by a general partner or the proprietor, respectively.
- c. For a public agency: by either a principle executive officer or ranking elected official.
- d. For a LLC: either a member or manager given signing authority by the operating agreement of LLC.
- e. a "duly authorized representative" of one of the above.

Electronic access to Standard Provisions: https://www.waterboards.ca.gov/centralcoast/board/decisions/docs/wdr_standard_provisions_2013.pdf

Table of Contents

Coversheet	- 1 -
Table of Contents	- 3 -
Introduction	- 4 -
Section A: Data Tables and Graphs	- 10 -
Section B: Compliance and Performance	- 22 -
Section C: Flow Evaluation	- 26 -
Section D: Operator Certification	- 33 -
Section E: Operation and Maintenance	- 33 -
Section F: Laboratory Information	- 34 -
Section G: Sludge Management	- 35 -
Section H: Pretreatment	- 41 -
Section I: Salt and Nutrient Management Plan	- 42 -
Section J: Collection System Management Plan	- 42 -
Section K: Mercury Seals	- 47 -
Section L: Figures	- 49 -
Lab Reports	- 51 -

Introduction

Facility Objective: Carmel Area Wastewater District protects public health and enhances the environment by collecting and treating wastewater while recycling valuable resources for golf course irrigation in the Carmel Bay region.

Treatment Technologies Used

The CAWD Wastewater Treatment Plant (WWTP) has a permitted capacity of 3.0 million gallons per day (MGD) of dry weather flow. Current average dry weather flow (ADWF) is approximately 1.1 MGD which represents 37% of the permitted capacity. Of the 1.1 MGD, approximately two-thirds are from CAWD customers, and the remaining one-third is from Pebble Beach Community Service District customers.

During large storm events the inflows can increase up to eight times the dry-weather rates. This requires the plant equipment and processes designed to handle large hydraulic loads during the winter months.

Influent Pumping

The purpose of influent pumping is to lift the incoming untreated sewage from the terminus of the several interceptor sewers up and into the headworks from where the sewage can flow by gravity through the other treatment processes. Approximately 97% of the influent sewage is pumped at the influent pump station; the remaining 3% is discharged directly into the headworks from the Calle La Cruz pump station in the Carmel Meadows subdivision.

During power outages, a dual standby generator system automatically provides backup power to all four (4) influent pumps. There is always at least a 7-day supply of fuel onsite to power the standby generator.

Headworks

The headworks structure, together with the adjacent influent manhole, contains essentially all the pretreatment processes of the plant. Unit processes located within the headworks are influent flow measuring, automatic bar screening, grit removal and washing.

The automatic bar screens removes rags and other large solids from the raw sewage and into a hopper which stores the screenings until they are removed and disposed of at the landfill.

Grit (i.e. sand, coffee grounds, etc.) is removed from the raw sewage by means of settling in an agitated tank. The agitation keeps the lighter organic solids in suspension and allows the heavier solids to drop out and be removed by pumping the contents from the bottom of the tank into a grit classifier and washer. The grit washer further separates the heavier grit

particles from the lighter organic matter and the grit is then disposed of into a bin for disposal at the landfill.

Primary Sedimentation Tanks

The Primary Clari-Thickener tanks remove the majority of suspended solids from the wastewater by gravity settling. CAWD has two primary Clari-Thickener tanks for redundancy. The Clari-Thickener combines the feature of a Primary clarifier for removing settleable solids and floating matter (scum) and a thickening well for concentrating sludge prior to withdrawal for further treatment. Each tank has a mechanical scraper which rotates around the sloping bottom and pushes settled sludge to a sludge thickening zone and a sludge sump. Sludge is withdrawn from the tanks and is transported to the anaerobic digestion tanks. Floating matter is mechanically skimmed into collecting hoppers and is also transported to the anaerobic digestion tanks.

The primary sedimentation process is a physical process utilizing gravitational forces. Settleable and suspended solids, which are the major components of sludge and are heavier than water, settle out of the sewage along with any grit carryover from the headworks. Scum, which is lighter than water, floats to the surface and is removed by skimming. Approximately 60 to 65 percent of the suspended solids will be removed by gravitational forces as part of primary sedimentation.

Effluent from the primary sedimentation tanks overflows into double sided circumferential launders and then flows into either the primary equalization system or the aeration basins.

Primary Equalization

The flow equalization basins are designed to reduce flow to the treatment plant during daytime periods of high influent flow. Wastewater stored in the flow equalization basins is reintroduced into the normal wastewater stream at the option of the operator in order to maintain operation of the Reclamation facility when influent flows are low. This operation also ensures that influent flow can be prioritized for reclamation uses over discharge to the outfall.

The reintroduced flow is pumped back to the Headworks.

Diffusers are located in the flow equalization basin is to prevent stored wastewater from becoming septic.

Anoxic Selector

The Anoxic Selector mixes the return activated sludge (RAS) from the secondary clarifiers with effluent from the primary clarifiers and equally distributes the combined flow to Aeration Basins No. 4, 5, and 6.

Aeration (Biological Activated Sludge Process)

The aeration structures (basins) are designed to promote the growth of helpful bacteria organisms which consume the nutrients in the sewage. This is called the "activated sludge" process. By injecting large amounts of oxygenated air, these bacteria thrive and consume the biological oxygen demand, ammonia, carbohydrates, fats, etc. in the sewage and convert it into bacterial mass or "sludge" for removal in the Secondary Sedimentation Tanks.

The aeration structures can hold about 1.15 million gallons total divided into three separate basins. The helpful bacteria population is maintained in the basins by returning a portion of the sludge separated out of the water downstream in the Secondary Sedimentation Tanks back to the front of the Aeration Basins. This allows the helpful bacteria to live out their life cycle in the treatment process, all the while providing a beneficial service to the treatment process.

CAWD utilizes A2O process which creates different zones in the aeration basins, some with oxygen (aerobic), and some without oxygen (anoxic/anaerobic). The different zones allow for selecting the types of bacteria that are the most beneficial and to enhance the nitrification process.

Aeration in each basin is accomplished by air blowers feeding fine bubble diffusers at the bottom of each basin. Air flow is regulated by automatic dissolved oxygen (DO) control systems.

Mixed Liquor Distribution Structure

The Mixed Liquor Distribution Structure receives and combines the flows exiting the Aeration Basins. Combined flow is then gravity-fed to the Secondary Clarifiers. Two gates are used to control flow to each of the two Secondary Clarifiers.

Secondary Sedimentation Tanks

The Secondary Sedimentation Tanks are similar to the Primary Sedimentation Tanks except they are designed to remove lighter suspended solids. There are two tanks, each equipped with rotating mechanical sludge and scum collectors. The effluent from the Aeration Basins enters each tank through the bottom, rises up through the center column, and then is distributed into the sedimentation zone. Settled sludge is removed from the tank and clean water flows over weirs to the next step in the process (disinfection). The sludge is pumped back to the Aeration process to maintain the helpful microorganism population or wasted to the solid's treatment process. Scum is collected from the surface of the wastewater in each tank and returned to a sump in the Aeration Structure, from which it is then pumped to the solid's treatment process.

The clean water coming out of the Secondary Sedimentation Tanks is clear and has exceptionally low concentrations of bacteria and ammonia. Disinfection/Dechlorination is next

and is the final treatment step before this water is sent to the Reclamation Facility or to the Ocean.

Secondary Effluent Diversion Structure

The Secondary Effluent Diversion Structure serves two purposes:

1. Aiding in downstream disinfection - Secondary flow enters the structure where an injection of Sodium Hypochlorite and aqueous ammonia is used for disinfection leading into the chlorine contact channels at the Chlorination Building. When ammonia is introduced under the appropriate conditions, it reacts with hypochlorous acid to produce monochloramine. Monochloramine is used as a disinfectant rather than free chlorine because free chlorine is detrimental to the Reverse Osmosis membranes at the Reclamation Facility. The amount of chlorine and ammonia required to produce monochloramine is based on the ideal weight ratio of 5:1. The desired ratio is controlled, monitored, and driven by programmable logic controllers at the in the Sodium Hypochlorite/Sodium Bisulfite Building and the ammonia injection system at the Tertiary Facilities.

2. Flow Management – The Secondary Diversion Structure also receives the effluent flow from the Chlorination Building and either directs the flow to the holding basin at the Tertiary Building prior to reclamation or to the Outfall Building for ocean discharge.

Disinfection/Dechlorination

The last step to clean the water is disinfection/dechlorination. Disinfection is accomplished using liquid chlorine (i.e., bleach) which kills bacteria and deactivates viruses and protozoa that may be harmful to human health. A small concentration of chlorine is maintained in the water for about 2 hours to make sure all of the harmful pathogens are killed or deactivated. The residual chlorine is then removed using liquid sodium bisulfite. At this point, the water is safe to send out to the ocean, but most of the time it is sent to the Reclamation Facility for further treatment to allow the water to be reused for irrigating golf courses in Pebble Beach.

Treated Water Pump Station and Ocean Outfall

The treated water is pumped to Carmel Bay, or it is treated further in the Reclamation Facility and sent to Pebble Beach golf courses for irrigation. The water that is pumped to the ocean the majority of the year is concentrated brine which is the water left after treatment through the Reverse Osmosis (RO) system in the Reclamation Facility. The RO system removes dissolved solids (i.e., salts), which are collected in the brine. This brine is then pumped to the ocean. The salt content of the brine is lower than the salt content in the ocean and so there are no detrimental effects associated with the brine. During winter storms, when flows increase, a portion of the secondary treated wastewater is not sent to the Reclamation Facility and goes directly out of the outfall.

A pipeline carries the treated water or brine to the ocean. The existing ocean outfall is a 24-inch diameter, concrete encased pipe with 10 diffuser ports along the pipe. Each port has a rubber “duckbill” type valve to prevent debris from entering the outfall pipe during periods of low flow. The diffusers are designed to quickly disperse the treated water into the receiving water so that there is no environmental degradation around the outfall.

Solids Treatment and Disposal

There are several individual processes that are utilized to manage and treat the solids generated from the wastewater treatment process. These are: Sludge Thickening, Anaerobic Digestion, and Dewatering.

Sludge Thickening

The lighter sludge generated by the Secondary Sedimentation Tanks and the Microfiltration Membranes (Reclamation) are sent to the Dissolved Air Flotation Sludge Thickener (DAFT) to thicken the sludge before sending it to the Anaerobic Digesters.

Thickening is achieved by adding fine air bubbles into a tank containing the light sludge. The air lifts the sludge particles to the surface so they can coalesce at the surface and be skimmed off in a more concentrated/thick state. This thicker sludge that is collected is sent to the Anaerobic Digesters. The liquid the solids are separated from is returned to the Headworks to be treated again through the plant.

This is not required for the sludge from the Primary Sedimentation Tanks which is already thick enough to send straight to the digesters.

Anaerobic Digestion

The solids treatment process takes sludge and other solids and places them in an anaerobic digester where the sludge is kept at about 95 degrees and anaerobic bacteria are utilized to stabilize the sludge and remove pathogens. The detention time in the anaerobic digesters is maintained at around 20 days or more.

A byproduct of the anaerobic digestion process is methane. CAWD uses the methane produced to generate electricity using two microturbines. The microturbines can produce about 15% of the power demand required by the wastewater treatment plant (not including the Reclamation Facility).

After the solids have been stabilized sufficiently by the digestion process the solids are held in a holding tank before they are sent to the dewatering equipment.

Dewatering is a physical/mechanical process used to reduce the moisture in digested sludge (biosolids). There are several reasons for dewatering sludge. In general, it is more economical to dispose of the dewatered sludge than it is to pump or haul liquid sludge to disposal sites because by reducing the moisture content, the sludge volume and weight are reduced.

The CAWD plant uses a belt filter press or a screw press to dewater the digested sludge. This equipment presses out the moisture from the sludge to create a dry material that is essentially dirt that can be land applied.

The dewatered sludge is hauled by truck to Kern County where it is used as a compost amendment for nonfood crops.

Targeted Removals of Main Pollutants

- BOD target removal 85% of influent average BOD per month.
- TSS target removal 85% of influent average TSS per month.
- Oil and Grease target removal 85% of influent average per quarterly.

Overview of Any Liquid or Solid Waste Produced

- Liquids see Section C Flow Evaluation
- Solid Waste see Section G Sludge Management

Upgrades Since the 2014 Permit was Issued

New Structures:

- Anaerobic Digester #2 - 450,000 gallons.
- Digester Control Building for Anaerobic Digester #2 with future space for cogeneration equipment.
- Ferric Chloride Storage and Dosing for Sulfide control in digesters.
- Sodium Hypochlorite/Sodium Bisulfite storage 9,000 gallons of each product, new chemical dosing pumps (with redundancy).
- Storm water pump station to retain all storm water collected on facility site and treated in the plant flow stream.
- Waste gas burner to meet the stricter clean air requirements.

Existing Structures that Received Upgrades

- Phase one completion 2017.
 - Dewatering Building received new screw-press and polymer systems.
 - Blower Building received new energy efficient blower and air diffuser membranes.
 - Dissolved Air Floatation Thickener received new solids collector and drive, sludge pumps, and air compression systems.

- Operations Building received new Motor Control Center, Programable Logical (PLC) Computer and Supervisory Control and Data Acquisition System (SCADA).
- Fresh Water System (#1 water system) Air Gap System with dual repressurization pumps.
- Return Activated Sludge (RAS)/Waste Activated Sludge (WAS) building received new Motor Control Center, Programable Logical (PLC) Computer and Supervisory Control and Data Acquisition System (SCADA).
- The Chlorination Building removed all Chlorine (CL₂) gas system.
- Phase two completion 2023 included:
 - Influent pump station: 4 new influent pumps and Motor Control Center for building.
 - Headworks equipment: replaced influent flow meter, installed new slide gates, new grit collector drive, new grit washer, installed new influent screens and rag compactor. New Motor Control Center and instrumentation.
 - Chlorination/Dechlorination Building: installed new Motor Control Center and Programable Logic Controller. New chlorine analyzers and sample pumps.
 - Final Effluent Pump Station: replaced Motor Control Center and Programable Logic Controller. Replaced isolation valves on all pumps in station. Replaced effluent flow meter. Installed mixing system in wet well to prevent solids building up on the floor of the station.
 - Replaced main electrical feeds to all areas of Motor Control Center replacement including new power to Laboratory during power failures.

Section A: Data Tables and Graphs

TABULAR AND GRAPHICAL SUMMARY OF 2023 NPDES REPORTABLE DATA

Month	Influent Flows			BOD			Suspended Solids		
	Total	CAWD total	PBCSD total	Influent mg/l	Effluent mg/l	Effluent lbs/day	Influent mg/l	Effluent mg/l	Effluent lbs/day
Jan	81.216	45.825	35.391	167	4	60	274	7	117
Feb	43.194	26.652	16.542	299	4	42	335	6	73
Mar	72.259	41.933	30.326	215	5	93	274	7	146
Apr	43.486	27.079	16.407	274	6	23	391	5	24
May	41.342	24.661	16.681	269	10	14	417	7	11
Jun	36.572	23.256	13.316	470	11	14	735	10	10
Jul	38.634	26.289	12.345	525	13	11	672	32	29
Aug	37.315	25.785	11.530	446	12	11	872	20	18
Sep	33.729	23.238	10.491	365	13	11	674	13	11
Oct	33.587	23.691	9.896	302	9	7	412	7	6
Nov	32.310	22.945	9.365	374	10	7	538	9	7
Dec	37.449	26.266	11.183	262	11	9	578	11	8

Lab Data 1

Month	Sett Solids Effluent ml/l	CL2 Residual Effluent mg/l	Removal Efficiency		pH		O&G	
			BOD %	T.S.S. %	Min	Max	Effluent mg/l	Effluent lbs/day
Jan	0.11	NODI(B)	97	97	6.7	7.9	NODI(B)	NODI(B)
Feb	NODI(B)	NODI(B)	99	98	6.9	7.4	NODI(B)	NODI(B)
Mar	NODI(B)	0.68	98	97	6.7	7.2	NODI(B)	NODI(B)
Apr	NODI(B)	NODI(B)	98	99	6.8	7.3	NODI(B)	NODI(B)
May	NODI(B)	NODI(B)	96	98	6.9	7.2	NODI(B)	NODI(B)
Jun	0.12	3.42	98	99	6.9	7.3	NODI(B)	NODI(B)
Jul	NODI(B)	1.09	98	95	6.8	7.1	NODI(B)	NODI(B)
Aug	NODI(B)	NODI(B)	97	98	6.9	7.3	NODI(B)	NODI(B)
Sep	NODI(B)	0.43	97	98	7.0	7.4	NODI(B)	NODI(B)
Oct	NODI(B)	NODI(B)	97	98	6.9	7.3	NODI(B)	NODI(B)
Nov	NODI(B)	NODI(B)	97	98	6.7	7.2	NODI(B)	NODI(B)
Dec	NODI(B)	NODI(B)	96	98	6.9	7.2	NODI(B)	NODI(B)

NODI(B) = NO DETECTION

Lab Data 2

Month	Turbidity	Ammonia Effluent ug/l	Nitrate Effluent mg/l	Effluent	Sludge Cake	Effluent Coliform	Urea Effluent mg/l	Silicate Effluent mg/l
	Effluent NTU's			Temp Deg. F	Total Cu.Yds.	Bacteria mpn/100 ml		
Jan	2.96	NODI(B)	17.5	63.0	116.3	6.3	48	35
Feb	2.28	12.4	31.8	63.0	148.3	5.2	92	52
Mar	2.86	3.99	5.1	63.5	169.2	6.3	42	27
Apr	1.04	31.5	165	68.0	160.7	2.0	145	262
May	1.32	31.6	187	69.1	183.0	NODI(B)	138	207
Jun	2.46	17.0	170	69.8	140.0	NODI(B)	235	220
Jul	1.65	28.1	196	72.3	154.5	2.0	154	196
Aug	1.42	25.7	176	76.1	135.6	1.0	179	208
Sep	1.74	32.9	211	73.2	153.2	NODI(B)	145	243
Oct	1.34	37.2	58.3	73.9	170.8	NODI(B)	109	204
Nov	1.59	37.2	58.3	70.5	143.9	NODI(B)	128	124
Dec	1.53	23.7	235	68.2	105.5	NODI(B)	181	236

Lab Data 3

Receiving Waters									
Total Coliform			Fecal Coliform			Entero. Org.			
Month	K-4 mpn/ 100 ml	K-5 mpn/ 100 ml	K-6 mpn/ 100 ml	K-4 mpn/ 100 ml	K-5 mpn/ 100 ml	K-6 mpn/ 100 ml	K-4 mpn/ 100 ml	K-5 mpn/ 100 ml	K-6 mpn/ 100 ml
Jan	NA	NA	NA	NA	NA	NA	NA	NA	NA
Feb	NA	NA	NA	NA	NA	NA	NA	NA	NA
Mar	NA	NA	NA	NA	NA	NA	NA	NA	NA
Apr	NA	NA	NA	NA	NA	NA	NA	NA	NA
May	NA	NA	NA	NA	NA	NA	NA	NA	NA
Jun	NA	NA	NA	NA	NA	NA	NA	NA	NA
Jul	NA	NA	NA	NA	NA	NA	NA	NA	NA
Aug	NA	NA	NA	NA	NA	NA	NA	NA	NA
Sep	NA	NA	NA	NA	NA	NA	NA	NA	NA
Oct	NA	NA	NA	NA	NA	NA	NA	NA	NA
Nov	NA	NA	NA	NA	NA	NA	NA	NA	NA
Dec	NA	NA	NA	NA	NA	NA	NA	NA	NA

Lab Data 4

Effluent pH 2023

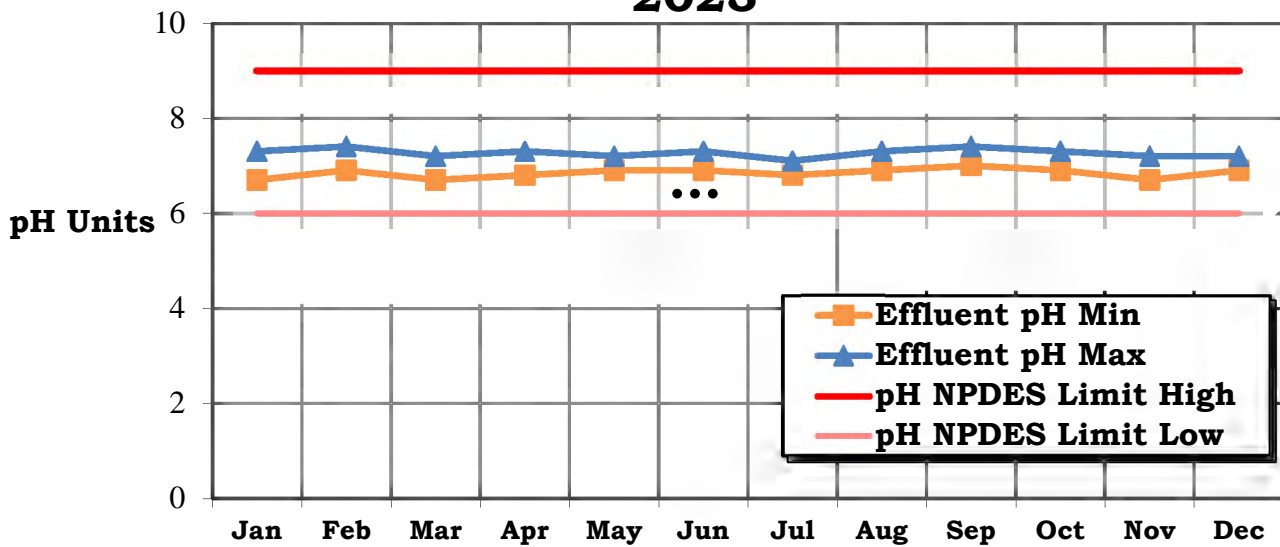

Graph 1

Effluent Turbidity 2023

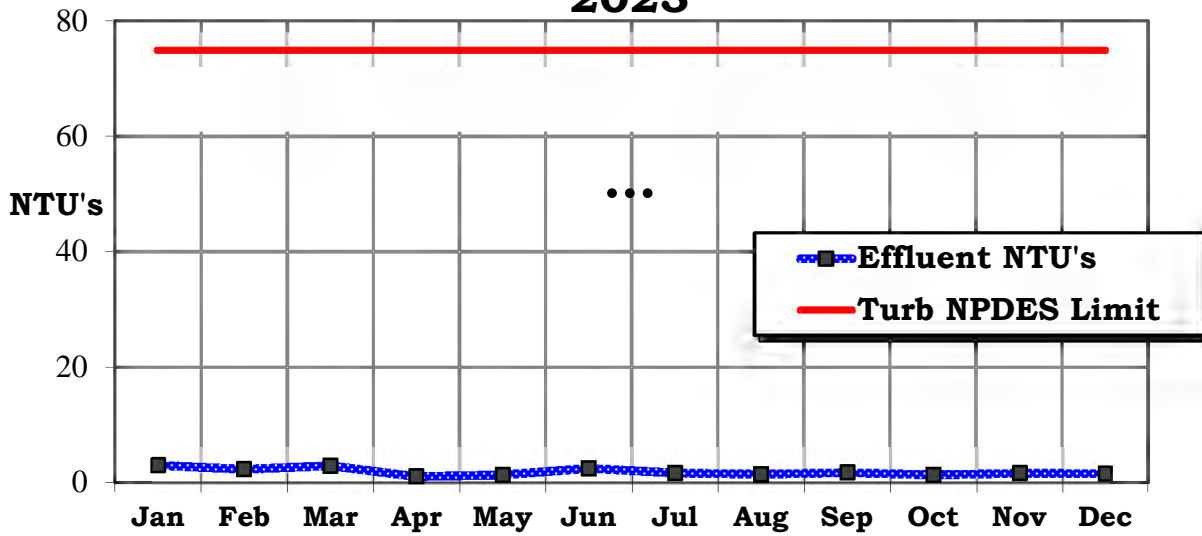

Graph 2

Effluent Setttable Solids 2023

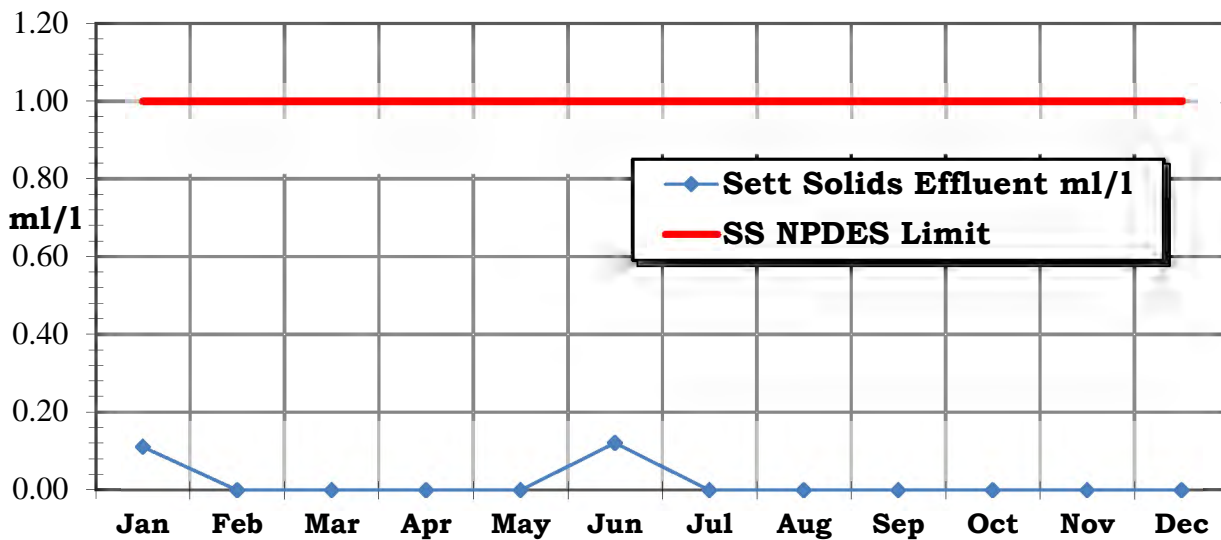

Graph 3

Effluent Chlorine Residual 2023

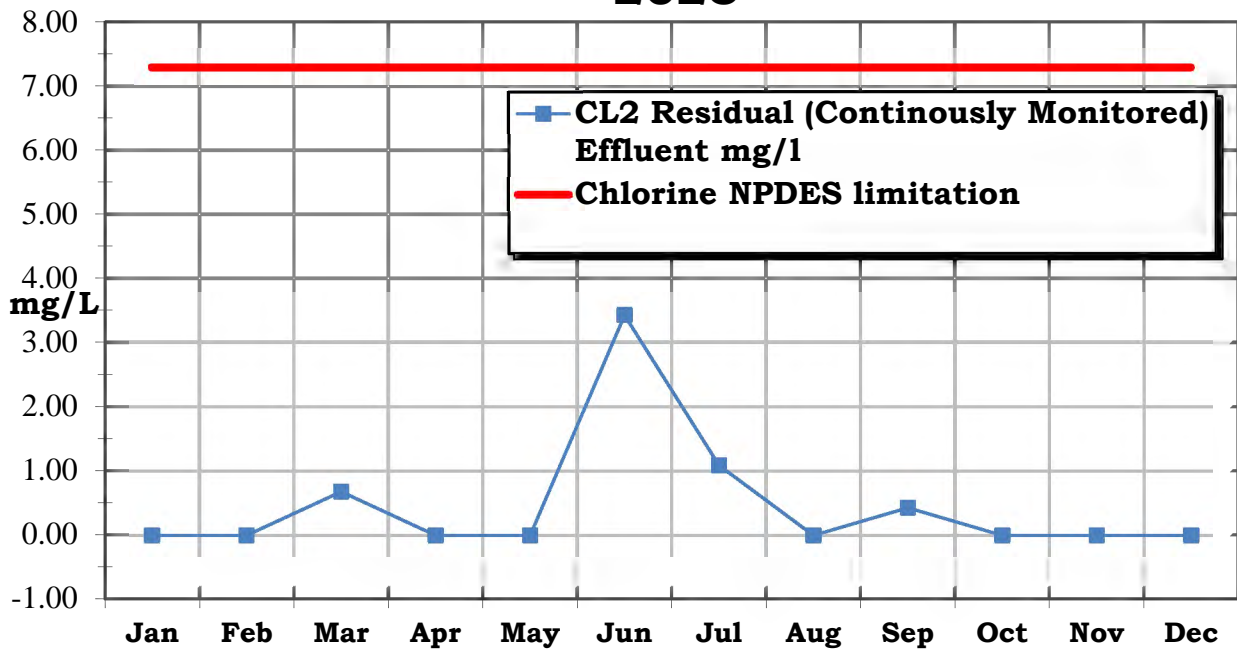

Graph 4

Annual Influent Flows 2023

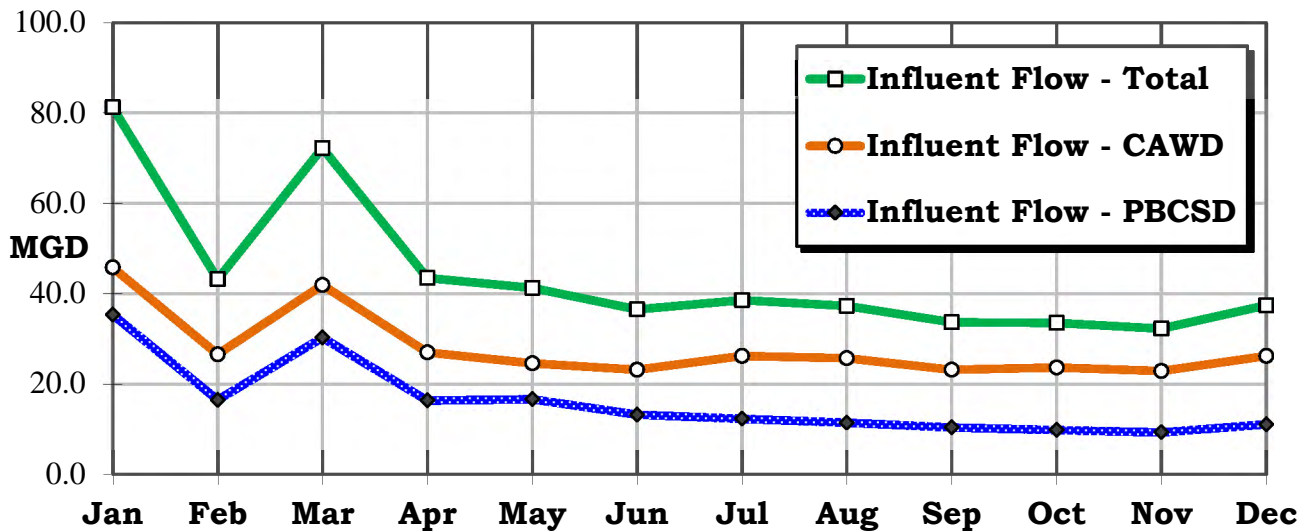

Graph 5

Influent / Effluent BOD 2023

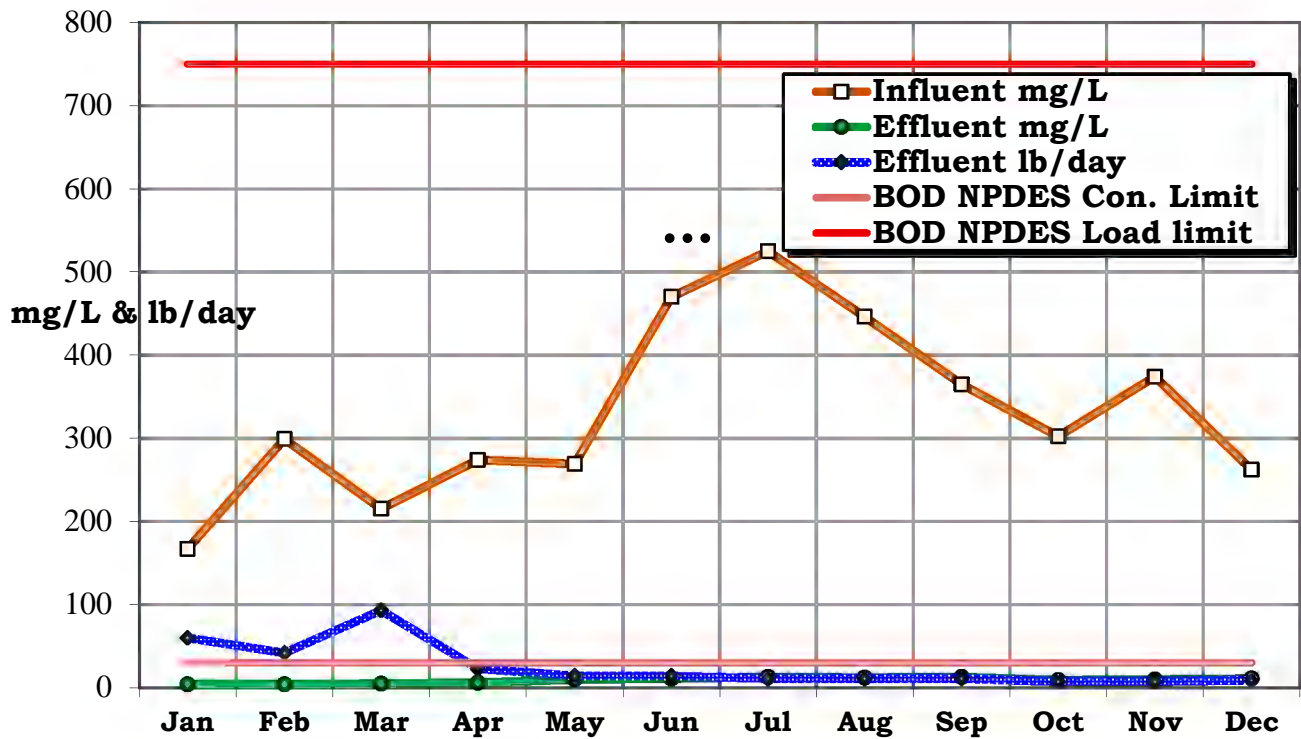

Graph 6

Effluent Urea / Silicate 2023

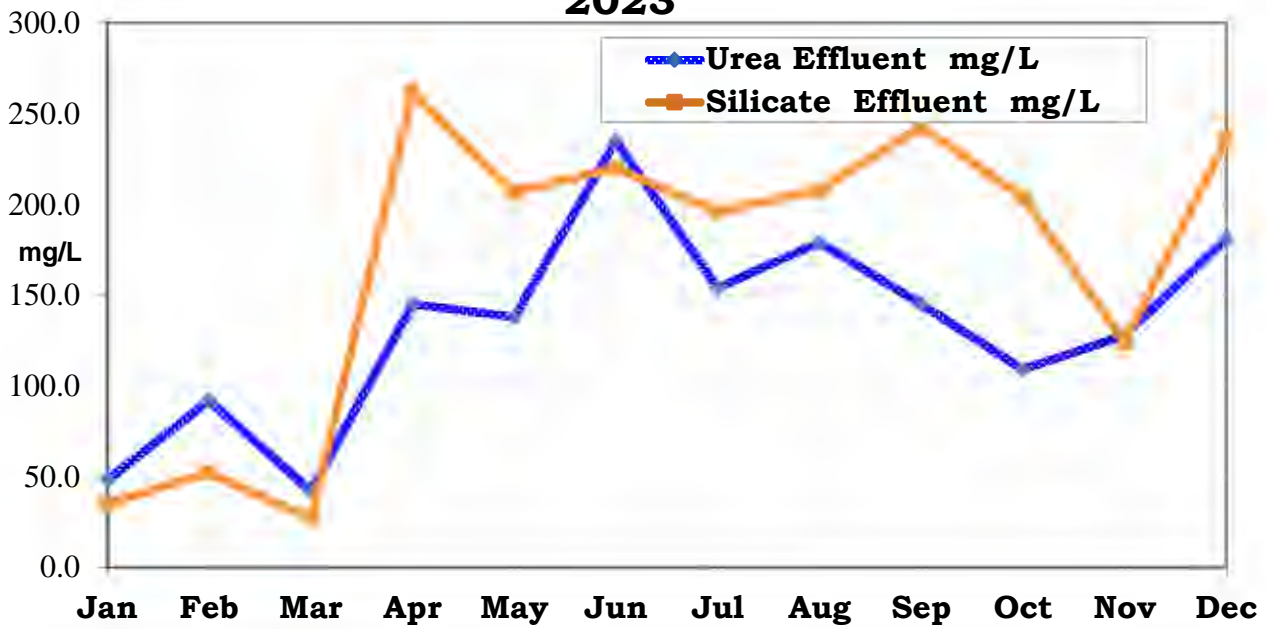

Graph 7

Effluent Ammonia / Nitrogen 2023

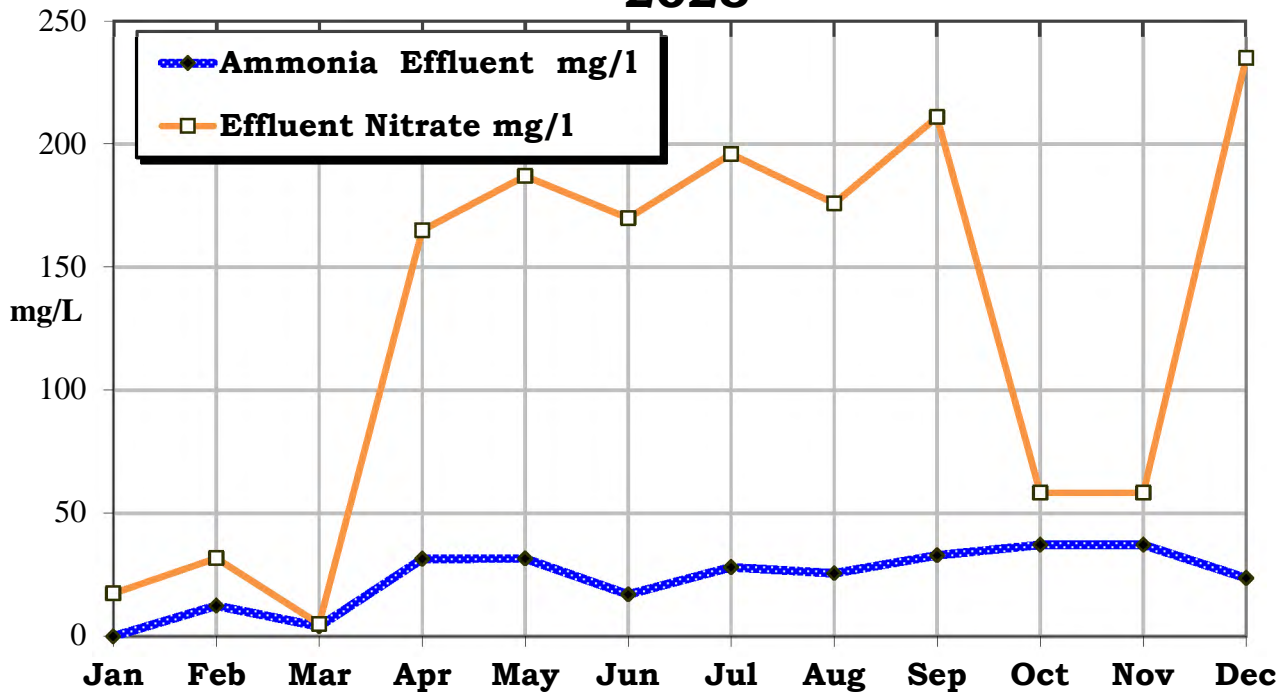

Graph 8

Influent / Effluent T.S.S. 2023

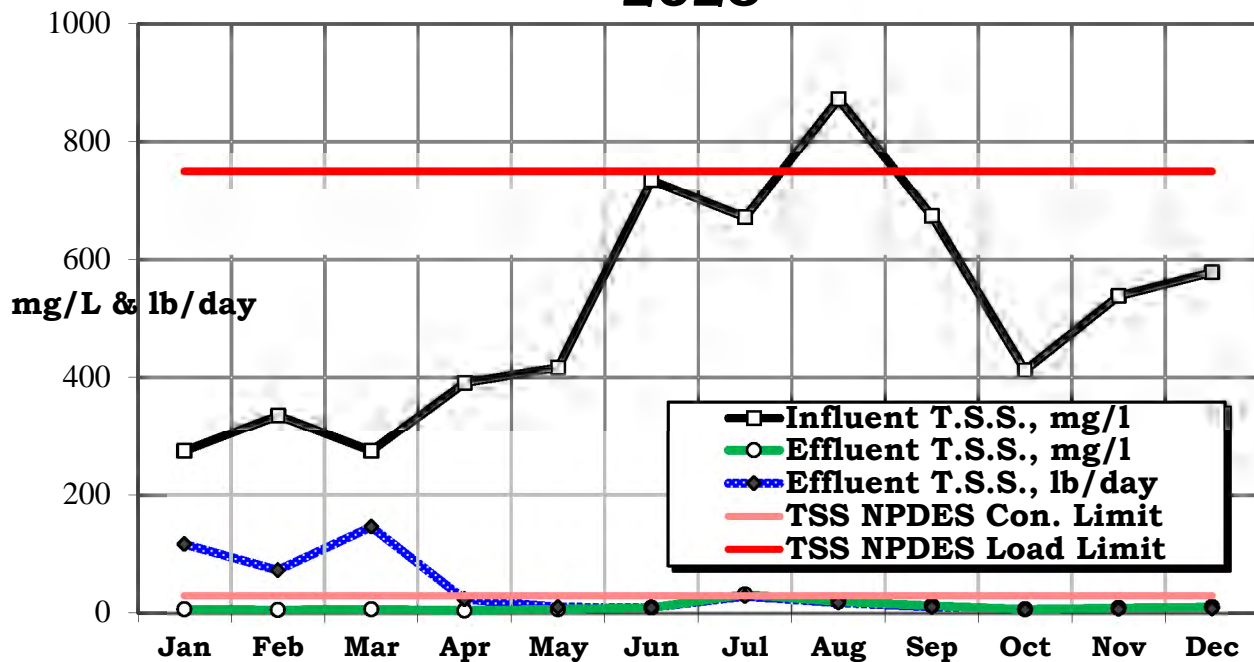

Graph 9

Effluent BOD & T.S.S Removal Efficiency 2023

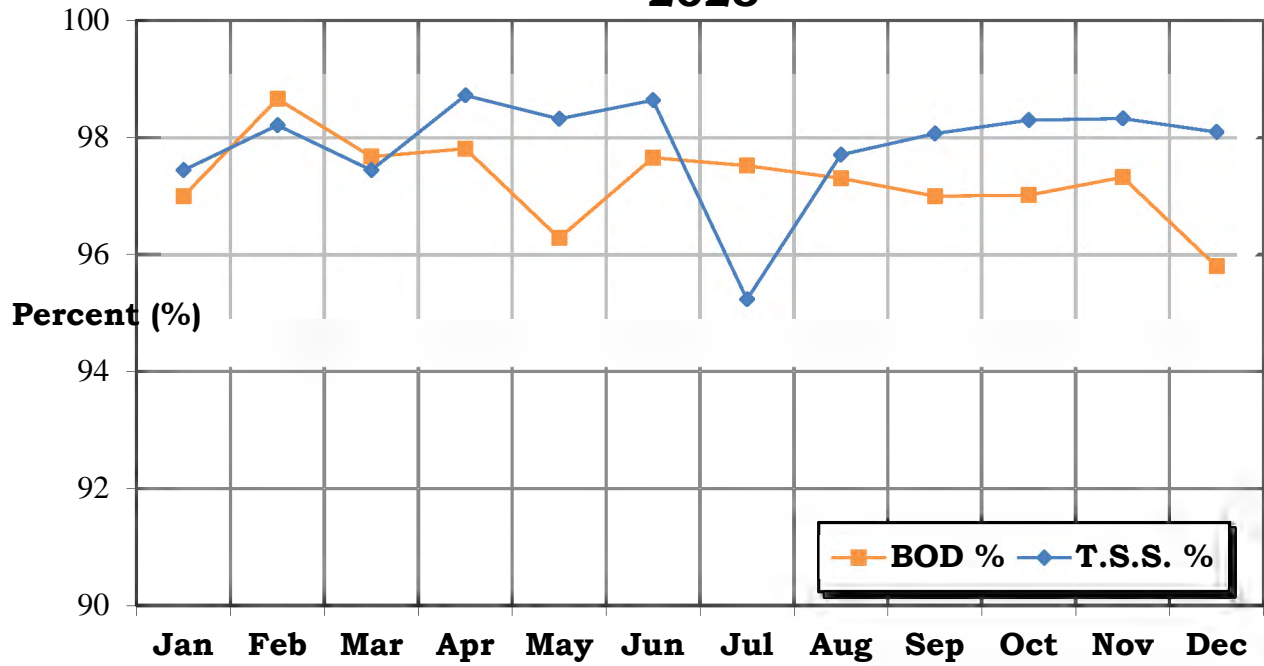

Graph 10

Effluent Temperature 2023

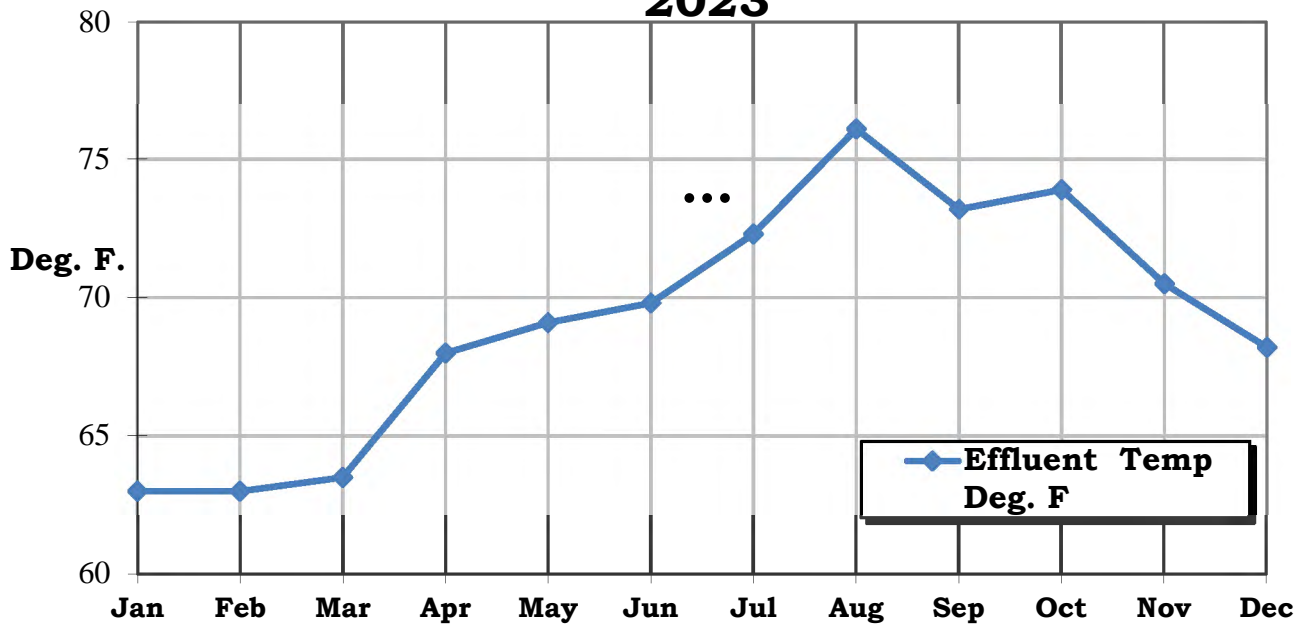

Graph 11

Sludge Hauling 2023

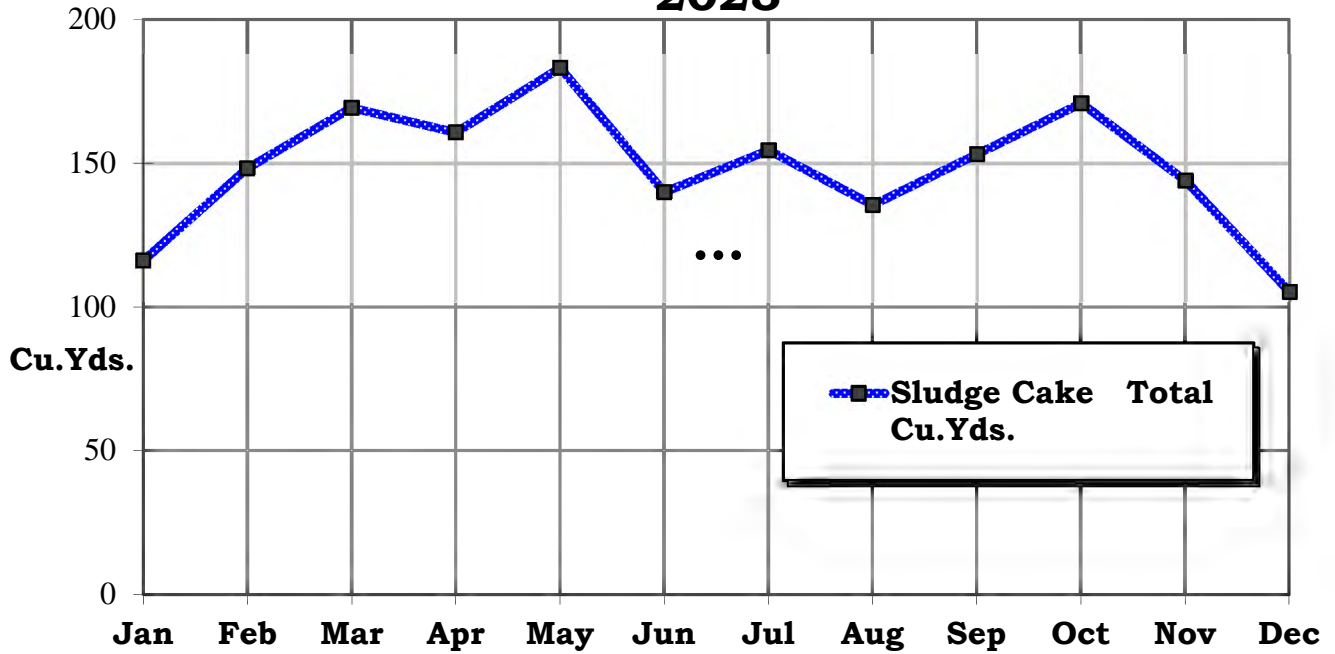

Graph 12

Effluent Oil & Grease 2023

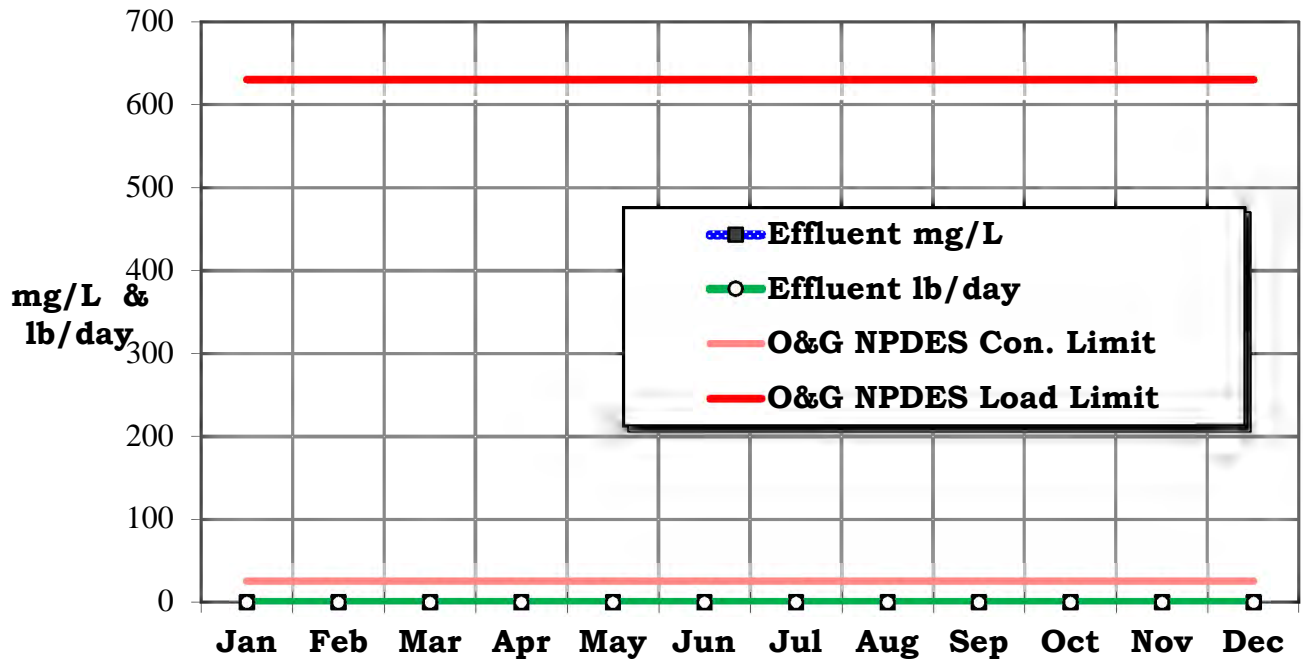

Graph 13

Receiving Water - Enterococcus Organisms Monthly Maximum 2023

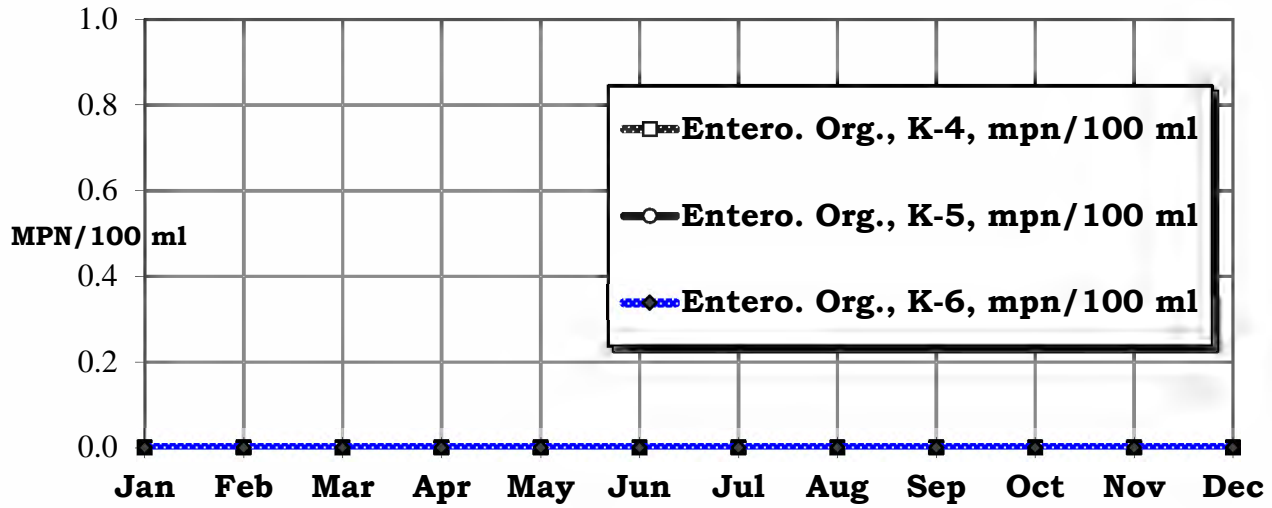

Graph 14

Receiving Water - Fecal Coliform Monthly Maximum 2023

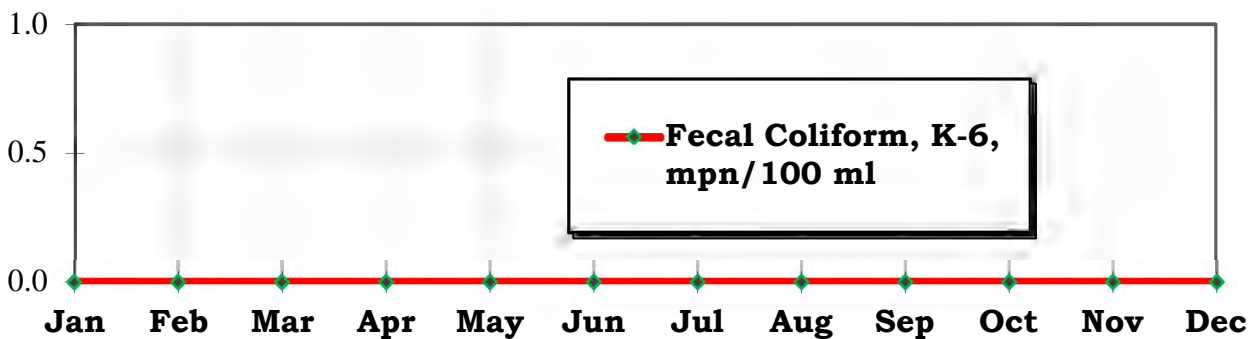
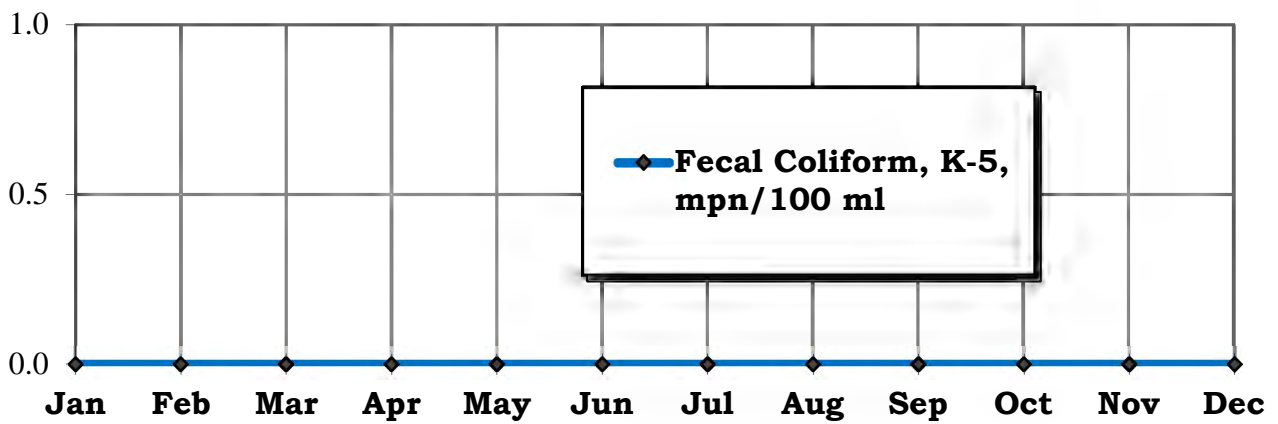
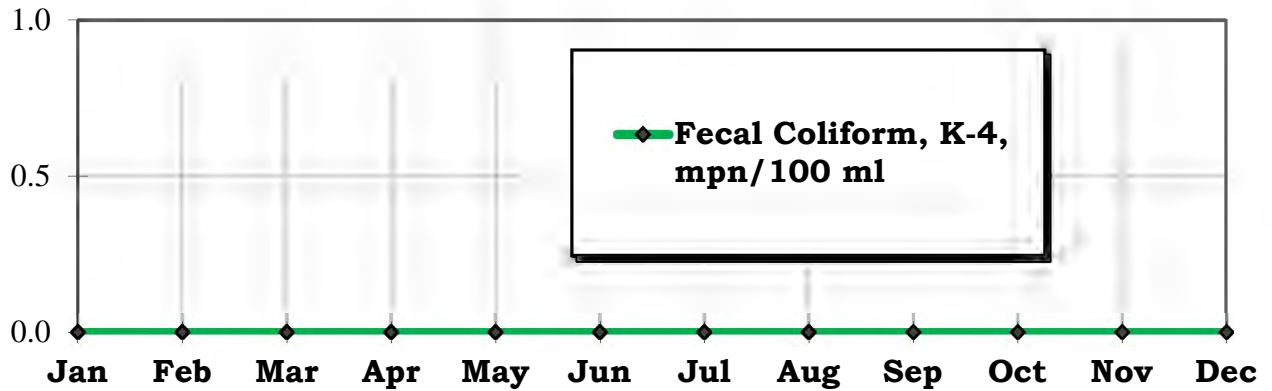

Graph 15

Receiving Water - Total Coliform Monthly Maximum

2023

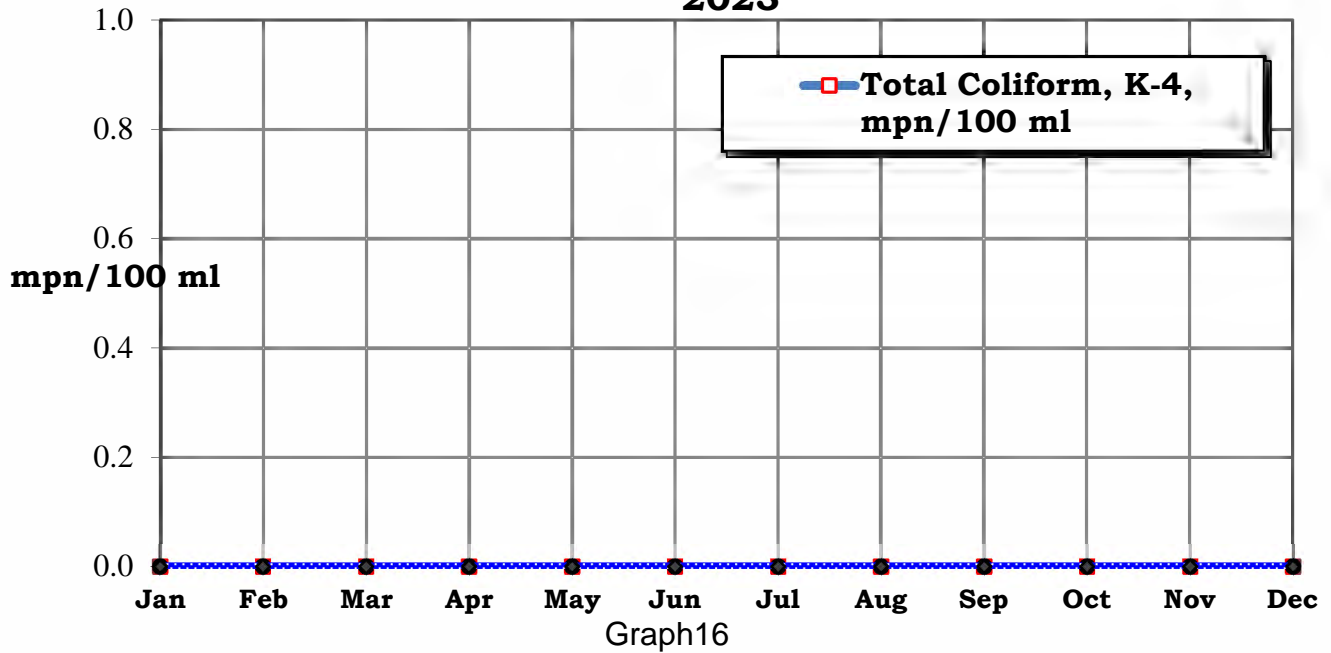

Effluent Coliform Monthly Average

2023

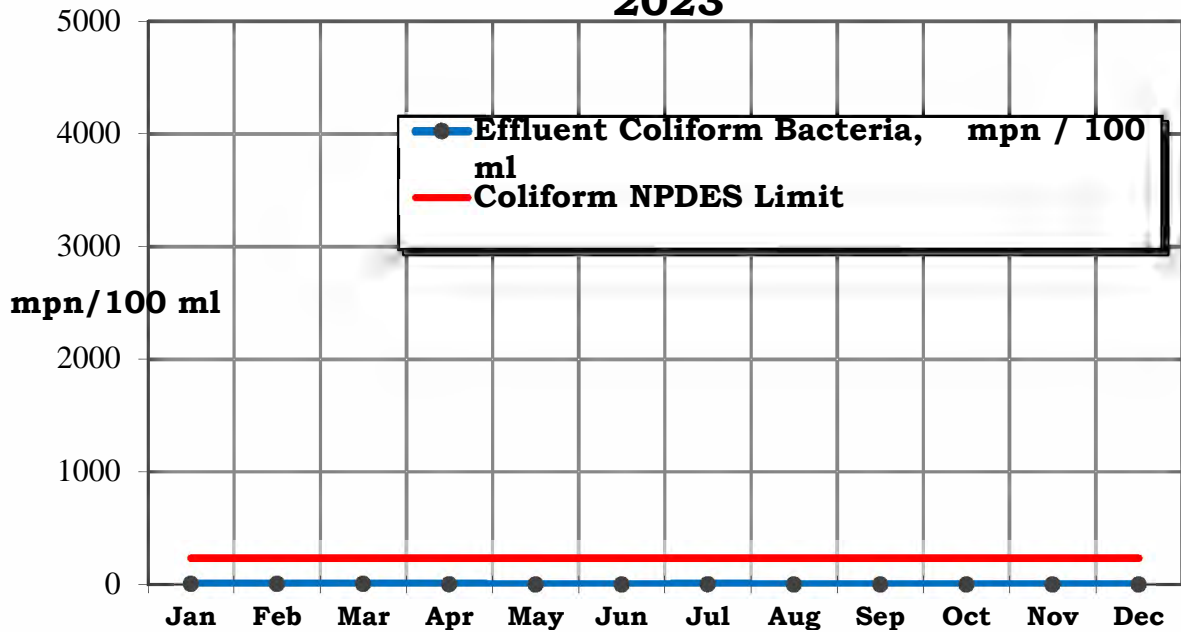

Graph 17

Water Supply Data

Please see the attached Water Supply Data, Water quality report.

Section B: Compliance and Performance

- Treatment facility performance through percent removal of main pollutants.
 - BOD percent removal (2023 annual average) was 97.3%
 - TSS percent removal (2023 annual average) was 97.9%
 - CBOD percent removal (2023 annual average) was 97.2%
 - Coliform inactivation for 2023 was 99+%
 - Oil and Grease percent removal (2023 annual average) was 99.9+%
- Discussion of the previous year's compliance record.
- Any nuisance conditions or system problems.
 - None at this time.

Carmel Area Wastewater District (CAWD) had six (6) incidents of noncompliance for the year 2023 for National Pollutant Discharge. The NPDES order No. R3-2014-0012 (B) Effluent Limitations- Discharge 001, Table 4 states, 1. "Total Suspended Solids (TSS) Maximum Daily of 90 mg/L" 2. "Total Suspended Solids (TSS) Average Weekly of 45 mg/L, and "Total Suspended Solids (TSS) Average Monthly of 30 mg/L for Carmel Area Wastewater District (CAWD).

CAWD experienced five (5) total violations for the month of July 2023.

1. Three (3) exceedances of the Maximum Daily limit of 90 mg/L.
 - a. July 14th the report valve was 96 mg/L.
 - b. July 18th the report valve was 127 mg/L.
 - c. July 20th the report valve was 126 mg/L.
2. One (1) exceedance of the Maximum Average Weekly of Sunday through Saturday of 45 mg/L.
 - a. The week of July 16th through July 22nd the report value was 74 mg/L.
3. One (1) exceedance of the Monthly Average of 30 mg/L.
 - a. The monthly average for TSS for the month of July 2023 was 32 mg/L.

Effluent Building Bypass Event:

On July 14, 2023, as part of the Wastewater Treatment Plant Electrical/Mechanical Rehabilitation and Sludge Holding Tank Replacement Project the Effluent Building (EFF-001) required a pump bypass system of the effluent pump wet well to be installed so all the upgraded electrical and mechanical work could be performed. This bypass required the use of two remote pumps and associated piping.

The remote pumps suction piping was installed in the first wet well entering the Effluent pump station building. This small wet well combines the RO Reject flow stream with any plant secondary effluent which then flows into the effluent pumps wet well for final disposal through the plant outfall line for ocean discharge. Since 2008, during dry weather flows, this first wet well receives only RO Reject flow during the summer irrigation season.

The wet well is covered with open grating which allows sunlight into wet well which helps promote algae growth on the walls of the wet well. This algae growth is sloughing off as the water level changes along with the turbulence created by the effluent entering the small size of the wet well (See attached photos).

A consequence of the two factors listed above and the size of the wet well allowed the temporary installed bypass pump system suction hoses to stir up any settled solids within the wet well caused an elevated Total Suspended Solids composite sample that exceeded the 90 mg/L as outline in Effluent Limitations-Discharge 001 on July 14th, 18th, and 20th, Table 4, TSS Maximum Daily concentration outlined in NPDES permit R3-2014-0012.

Permit Violation Events:

On July 15th, 17th, and 19th, 2023, laboratory staff performed the required total suspended solids analysis from the 24Hr composite sampler at discharge point EFF-001 which resulted in a concentration of 96.0 mg/L, 127 mg/L, and 126 mg/L. Since RO Reject concentrate is the only flow stream sent for ocean discharge staff performed an analysis on 24-hour composite samples collected prior to the effluent bypass pump from the RO Reject concentrate which resulted in a TSS concentration average of 1.2 mg/L during the same periods.

Corrective Measures: Staff has washed down the walls of the wet well to prevent the algae growth from attaching to the walls and temporary piping. However, the temporary pump suction hoses prevented staff from gaining proper access to the wet well thus washing the wet well walls has helped a little, but not eliminating the problem completely.

Staff initiated a flush program on the small wet well by pumping plant effluent back into the headworks three times a week while the effluent building upgrades are taking place for the remainder of July and August. Staff also covered the smaller wet well with black plastic to prevent algae growth in the wet well. This flushing scheduled kept the Effluent TSS in the range of 16 to 27 mg/L well below the Maximum Daily, weekly and monthly limits for the last part of July and August.

CAWD experienced one (1) total violation for the month of August 2023.

1. One (1) exceedance of the Maximum Daily limit of 90 mg/L.
 - a. August 2nd the report value was 96 mg/L.

Effluent Building Bypass Event:

On July 14, 2023, as part of the Wastewater Treatment Plant Electrical/Mechanical Rehabilitation and Sludge Holding Tank Replacement Project the Effluent Building (EFF-001) required a pump bypass system of the effluent pump wet well to be installed so all the upgraded electrical and mechanical work could be performed. This bypass required the use of two remote pumps and associated piping.

The remote pumps suction piping was installed in the first wet well entering the Effluent pump station building. This small wet well combines the RO Reject flow stream with any plant secondary effluent which then flows into the effluent pumps wet well for final disposal through the plant outfall line for ocean discharge. Since 2008, during dry weather flows, this first wet well receives only RO Reject flow during the summer irrigation season.

The wet well is covered with open grating which allows sunlight into wet well which helps promote algae growth on the walls of the wet well. This algae growth is sloughing off as the water level changes along with the turbulence created by the effluent entering the small size of the wet well.

A consequence of the two factors listed above and the size of the wet well allowed the temporary installed bypass pump system suction hoses to stir up any settled solids within the wet well caused an elevated Total Suspended Solids composite sample that exceeded the 90 mg/L as outline in Effluent Limitations-Discharge 001 on August 2nd, Table 4, TSS Maximum Daily concentration outlined in NPDES permit R3-2014-0012.

Permit Violation Events:

On August 2nd, 2023, laboratory staff performed the required total suspended solids analysis from the 24Hr composite sampler at discharge point EFF-001 which resulted in a concentration of 96.0 mg/L. Since RO Reject concentrate is the only flow stream sent for ocean discharge staff performed an analysis on 24-hour composite samples collected prior to the effluent bypass pump from the RO Reject concentrate which resulted in a TSS concentration average of 1.2 mg/L during the same periods.

Corrective Measures: Staff has continued washing down the walls of the wet well to prevent the algae growth from attaching to the walls and temporary piping. However, the temporary pump suction hoses prevented staff from gaining proper access to the wet well thus washing the wet well walls has helped a little, but not eliminating the problem completely.

Staff initiated a flush program on the small wet well by pumping plant effluent back into the

Carmel Area Wastewater District
Secondary NPDES R3-2014-0012
2023 Annual Report

headworks three times a week while the effluent building upgrades are taking place for the remainder of August. Staff also covered the smaller wet well with black plastic to prevent algae growth in the wet well. This flushing scheduled kept the Effluent TSS in the range of 16 to 27 mg/L well below the Maximum Daily, weekly and monthly limits for the remainder of August.

The effluent lift station and outfall rehabilitation was completed on August 30th and back into normal operation on September 1st.

For Facilities That Measure Groundwater

This Facility does not have requirements to perform groundwater measurements – Not applicable.

Section C: Flow Evaluation

2021	INF Max Monthly Daily Flow MGD	INF Monthly Flow Total MG
January	3.873	37.781
February	1.584	36.638
March	1.472	35.896
April	1.251	34.571
May	1.310	35.889
June	1.251	35.322
July	1.277	37.117
August	1.299	36.578
September	1.203	31.800
October	3.049	35.625
November	1.224	33.282
December	3.358	55.861
Total annual flow		446.36

Inf. Flow Data 1

2022	INF Max Monthly Daily Flow MGD	INF Monthly Flow Total MG
January	2.019	40.807
February	1.281	31.191
March	1.317	34.43
April	1.439	35.101
May	1.254	35.091
June	1.176	33.717
July	1.209	36.043
August	1.283	35.881
September	1.503	33.941
October	1.116	31.961
November	2.04	34.002
December	4.102	57.963
Total annual flow		440.128

Inf. Flow Data 2

Carmel Area Wastewater District
 Secondary NPDES R3-2014-0012
 2023 Annual Report

2023	INF Max Monthly Daily Flow MGD	INF Monthly Flow Total MG
January	4.512	81.216
February	2.596	43.194
March	4.074	72.259
April	4.867	43.486
May	1.513	41.342
June	1.288	36.572
July	1.336	38.634
August	1.335	37.315
September	1.277	33.729
October	1.140	33.587
November	1.311	32.310
December	2.695	37.449
Total annual flow		531.093

Inf. Flow Data 3

2021

Average Inf. monthly dry weather flow

34.954 MG

Average Inf. monthly wet weather flow

39.439 MG

2022

Average Inf. monthly dry weather flow

34.258 MG

Average Inf. monthly wet weather flow

39.097 MG

2023

Average Inf. monthly dry weather flow

35.358 MG

Average Inf. monthly wet weather flow

53.158 MG

* Order No. R3-2014-0012 defines dry weather June-Nov, wet weather Dec-May

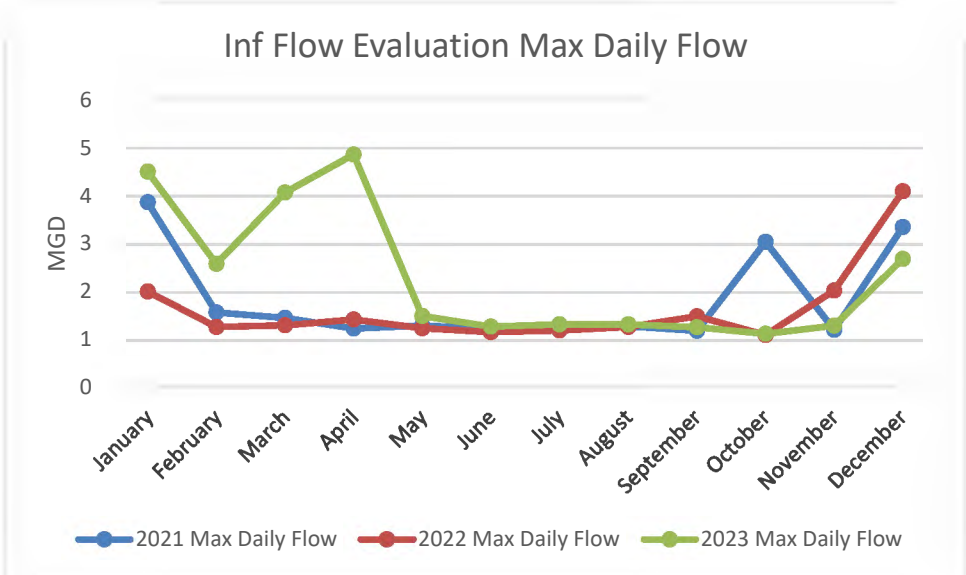

Graph 18

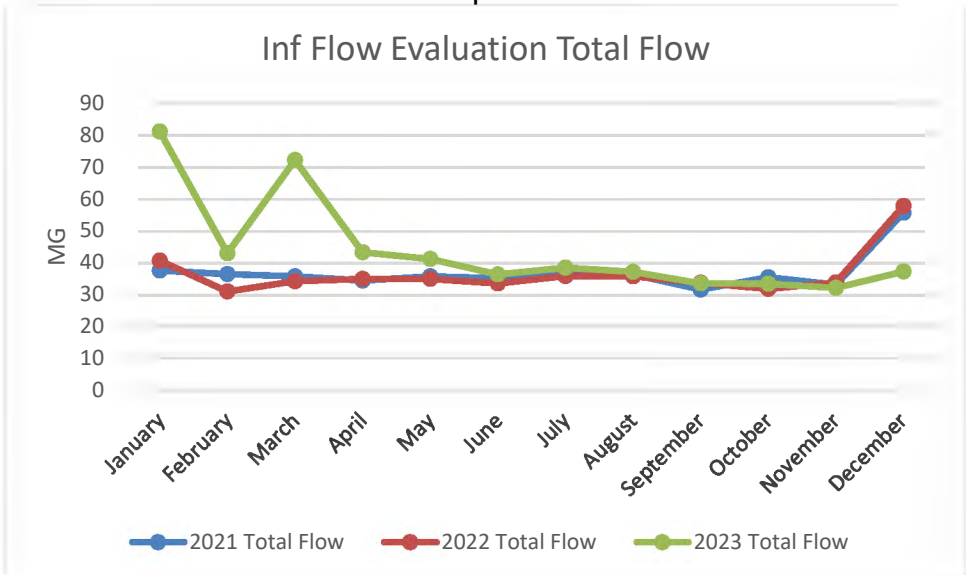

Graph 19

Carmel Area Wastewater District
 Secondary NPDES R3-2014-0012
 2023 Annual Report

	Eff Monthly Flow Total (MG)		
	2021	2022	2023
Jan	11.216	15.525	60.192
Feb	6.569	10.278	42.221
Mar	24.09	6.519	74.411
Apr	4.008	9.026	18.082
May	4.343	4.660	7.018
Jun	4.088	4.069	3.759
Jul	4.198	4.033	3.316
Aug	4.435	3.992	3.271
Sep	3.937	3.596	3.021
Oct	5.888	3.489	2.952
Nov	3.843	4.016	2.854
Dec	18.934	21.414	2.919

Eff Flow Evaluation 1

	Eff. Max Daily Flow Monthly (MGD)		
	2021	2022	2023
Jan	3.172	1.594	4.568
Feb	0.567	0.916	2.810
Mar	1.933	0.960	4.477
Apr	0.204	1.124	1.928
May	0.179	0.400	0.720
Jun	0.157	0.329	0.322
Jul	0.160	0.213	0.132
Aug	0.169	0.189	0.118
Sep	0.242	0.158	0.118
Oct	1.982	0.130	0.107
Nov	0.153	0.294	0.117
Dec	2.220	3.184	0.117

Eff Flow Evaluation 2

Annuals flow totals (MG)		
2021	2022	2023
95.548	90.617	224.016
Average dry weather flow (MGD)		
2021	2022	2023
0.144	0.127	0.105
Peak daily average-monthly wet weather flow (MGD)		
2021	2022	2023
0.380	0.370	1.126

Eff Totals, Avg Dry Weather Flow, and Peak Wet Weather Evaluation

2021	BOD Loading lb/day	TSS Loading lb/day
January	62	30
February	28	16
March	75	85
April	15	13
May	18	18
June	17	20
July	14	29
August	15	16
September	15	15
October	18	36
November	7	9
December	38	76

Eff Loading Data 1

2022	BOD Loading lbs/day	TSS Loading lbs/day
January	19	46
February	21	24
March	19	31
April	18	30
May	18	21
June	16	11
July	18	12
August	13	6
September	16	8
October	11	8
November	10	6
December	13	12

Eff. Loading Data 2

Carmel Area Wastewater District
 Secondary NPDES R3-2014-0012
 2023 Annual Report

2023	BOD Loading lbs/day	TSS Loading lbs/day
January	60	117
February	42	73
March	93	146
April	23	24
May	14	11
June	14	10
July	11	29
August	11	18
September	11	11
October	7	6
November	7	7
December	9	8

Effluent Loading Data 3

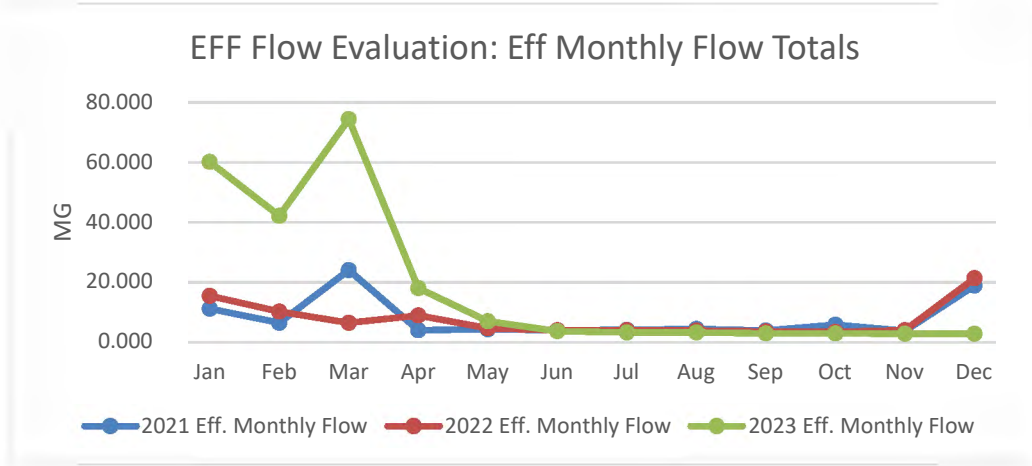

Graph 20

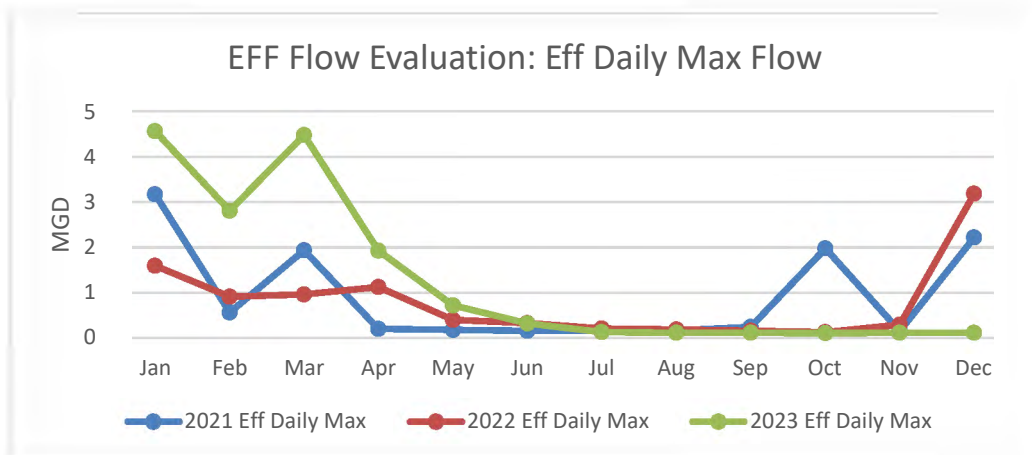

Graph 21

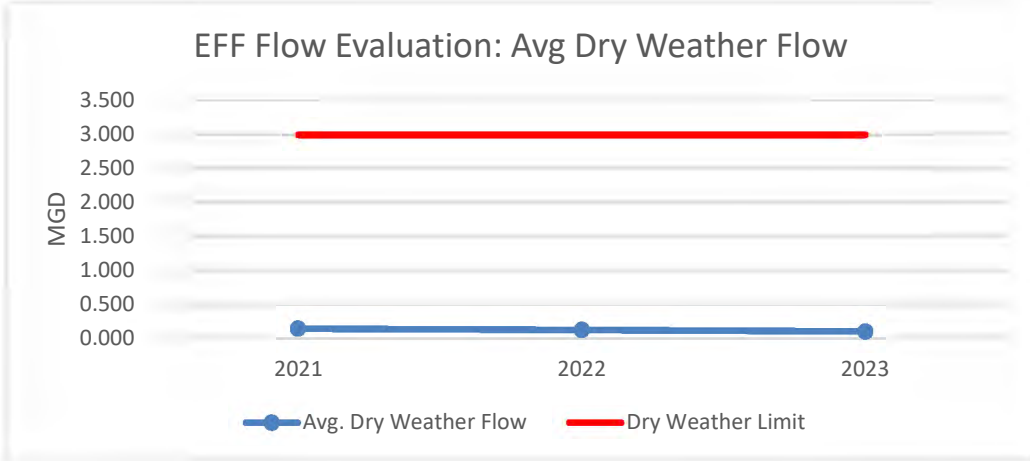

Graph 22

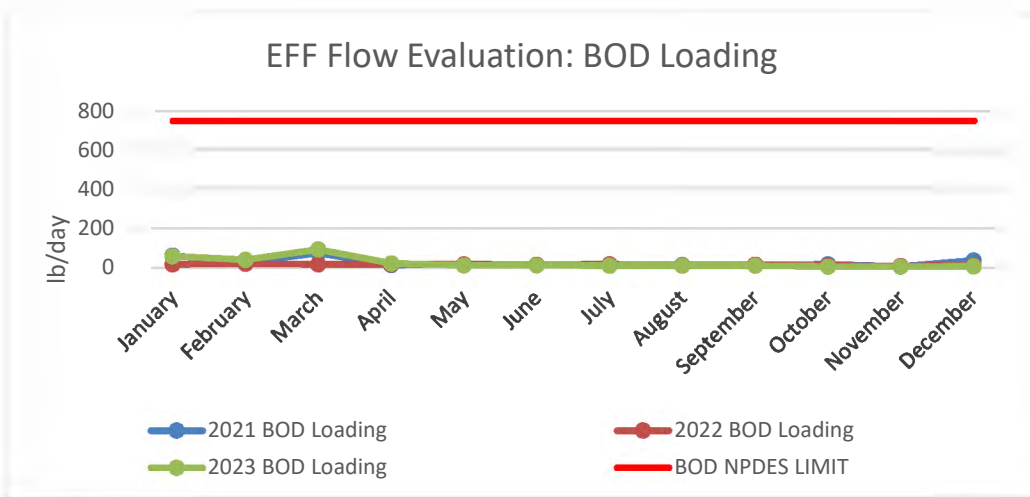

Graph 22

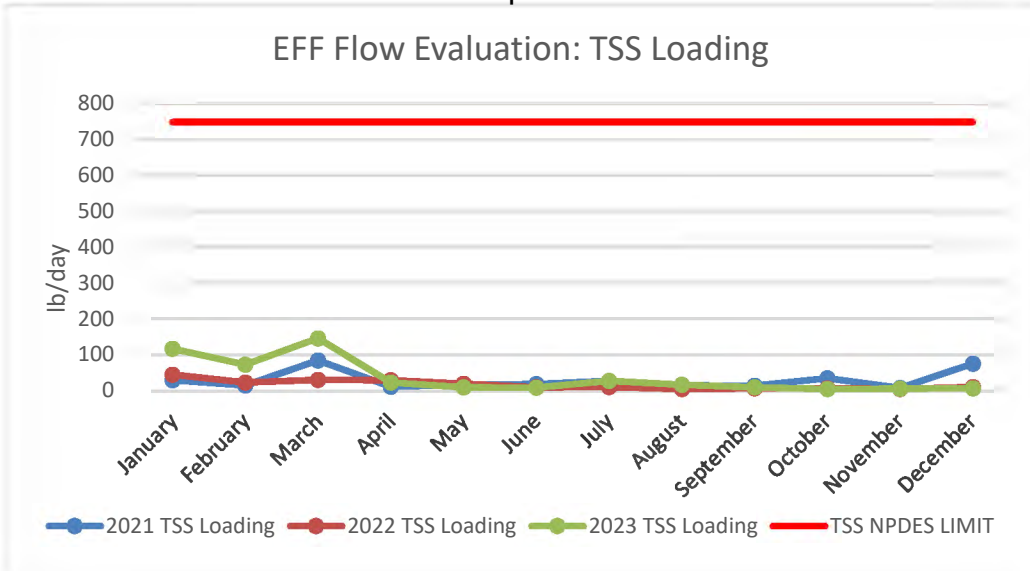

Graph 23

To date there are no capital improvement projects current or forecasted that would increase flows to the wastewater treatment plant which would cause the plant effluent flows to reach 80% of permitted capacity. Based on the three-year trends our evaluation indicates the wastewater treatment plant will not reach the permitted capacity in the next four years. The wastewater treatment plant is designed for effluent flows of 4.0 MGD and permitted for 3 MGD (monthly average dry weather flow).

Section D: Operator Certification

Name	Operations Position	SWRCB Certification Level Maintained	License No.
Edward Waggoner	Operations Superintendent	V	4011
Kevin Young	Operations Supervisor	V	9660
Christian Schmidt	Senior Operator	III	28643
Chris Dixon	Senior Operator	III	40697
Michael Hooks	Senior Operator	III	41183
Michael Garrison	Operator II	III	10674
Charles DayEngel	Operator II	II	41894
Rommel Lopez	OIT	OIT	N/A

Section E: Operation and Maintenance

The Carmel Area Wastewater District's Operation and Maintenance Manual was written and submitted to the district in 1987 following a large expansion project which was completed in 1986.

Modifications to the existing secondary treatment facility in support of tertiary filtration required modifications and updates to the Operations and Maintenance Manual. These modifications were completed, and the manual submitted to the district in 1996

Updates to the Operations and Maintenance Manual were completed in 2018 by Engineering Firm Kennedy Jenks for the facility capital improvement project which was completed also in 2018.

- Standard Provisions A. 27

Contingency plans and equipment are constantly being reviewed and upgraded as staff recognize deficiencies in Standard Operating Procedures or new Federal or State Regulations that deem further additions to the current contingency plans.

CAWD currently has alternative power sources, standby-by generators, retention capacity, emergency operating procedures to protect against power outages, fire, earthquakes, flooding, and tsunami conditions.

An example is alternative power sources is a second standby generator to provide power to the treatment facility in case of a power outage. The second generator automatically runs in tandem with the main standby generator until the second generator verifies the main generator is providing power to the treatment facility. At that point the second standby generator will go into standby mode.

Section F: Laboratory Information

- 1 Monterey Bay Analytical Services
4 Justin Court, Suite D
Monterey, CA 93940
CA ELAP # 2385
- 2 Aquatic Bioassay & Consulting Laboratories, Inc.
29 North Olive Street
Ventura, CA 93001
CA ELAP# 1907
- 3 Carmel Area Wastewater District (CAWD)
PO Box 221842
Carmel, CA 93923
(831) 257-0432 -Phone
(831) 624-1478 -Fax
CA ELAP # 1804

4 Fruit Growers Laboratories (FGL)
853 Corporation St
San Luis Obispo, CA 93401
CA ELAP # 1573

Section G: Sludge Management

- Discussion of any solids waste generated at CAWD's Treatment Facility
 - There are three main types of solid waste generated at the Carmel Area Wastewater District's Treatment Facility.
 - Rags, rocks, and other large solids from the influent flow
 - Grit (i.e., sand, coffee grounds, eggshells, bone chips, and possible large organic particles such as food waste from the influent flow.
 - Class B Biosolids from anaerobic digestion.
- Technologies/Process prior to disposal of solid waste.
 - Rags: The automatic bar screen removes rags and other large solids from the raw sewage and puts it into a compactor that washes and dry is the material before being stored in a hopper which stores the screenings until they are removed and disposed of at the landfill.
 - Grit: is removed from the raw sewage by means of settling in an agitated tank. The agitation keeps the lighter organic solids in suspension and allows the heavier solids to drop out and be removed by pumping the contents from the bottom of the tank into a grit classifier and washer. The grit washer further separates the heavier grit particles from the lighter organic matter and the grit is then disposed of into a bin for disposal at the landfill.
 - Class B Biosolids: The solids treatment process takes sludge and other solids and places them in an anaerobic digester where the sludge is kept at about 95 degrees and anaerobic bacteria are utilized to stabilize the sludge and remove pathogens. The detention time in the anaerobic digesters is maintained at around 20 days or more.

A byproduct of the anaerobic digestion process is methane. CAWD uses the methane produced to generate electricity using two microturbines. The microturbines can produce about 15% of the power demand required by the wastewater treatment plant (not including the Reclamation Facility).

After the solids have been stabilized sufficiently by the digestion process the solids are held in a holding tank before they are sent to the dewatering equipment.

- Dewatering and Land Application

Dewatering is a physical/mechanical process used to reduce the moisture in digested sludge (biosolids). There are several reasons for dewatering sludge. In general, it is more economical to dispose of the dewatered sludge than it is to pump or haul liquid sludge to disposal sites because by reducing the moisture content, the sludge volume and weight are reduced.

The CAWD plant uses a belt filter press or a screw press to dewater the digested sludge. This equipment presses out the moisture from the sludge to create a dry material that is essentially dirt that can be land applied.

- Ultimate Destination of Solid Waste Material
 - Rag and Grit Material Destination
 - Re Gen (Monterey Regional Waste Management District Landfill) at 14201 Del Monte Blvd, Salinas, CA 93908
 - Class B Biosolids Destination
 - Liberty Composting, Inc.
 1241 Holloway Road
 Po Box 5
 Lost Hills, California 93249-0005

	Sludge Cake
Month	Total Cu.Yds.
Jan	116.3
Feb	148.3
Mar	169.2
Apr	160.7
May	183.0
Jun	140.0
Jul	154.5
Aug	135.6
Sep	153.2
Oct	170.8
Nov	143.9
Dec	105.5

Sludge Quantity

CARMEL AREA WASTEWATER DISTRICT
 Annual Biosolids Monitoring Report

Period: January 2023 - March 2023
 Sample Date: 27-Jan-23

Name POLLUTANTS	Concentration (mg/kg) Dry Weight unless indicated	EPA 503 pollution limits for land application	
		Pollutant Concentrations (40 CFR 503.13) (monthly avg.)	Ceiling Concentrations (40 CFR 503.13) (daily maximum)
Antimony	ND		
Arsenic	17.2	41 mg/Kg	75 mg/Kg
Barium	374.0		
Beryllium	3.6		
Boron	49.5		
Cadmium	0.961	39 mg/Kg	85 mg/Kg
Chromium	28.2		
Cobalt	0.862		
Copper	756.0	1500 mg/Kg	4300 mg/kg
Lead	35.2	300 mg/Kg	840 mg/kg
Molybdenum	26.4		75 mg\kg
Nickel	20.2	420 mg/Kg	420 mg/Kg
Phosphorus	36,800		
Selenium	8.9	100 mg/Kg	100 mg/Kg
Silver	ND		
Thallium	ND		
Vanadium	20.2		
Zinc	1320.0	2800 mg/Kg	7500 mg/Kg
Ammonia Nitrogen	4500		
Cyanide, Total	<1		
Nitrate Nitrogen	ND		
Nitrogen, Total Kjeldahl	42,000		
pH	6.86		
% Solids	28.8%		
Mercury	0.2	17 mg/Kg	57 mg/Kg
Grease/Oil	1010		
Hex Chromium	ND		

Pathogen Reduction (40 CFR 503.32)

Class B - (PSRP) Anaerobic Digestion at 95 F for minimum of 15 days

Vector Attraction Reduction (40 CFR 503.33)

Option 1 - VS reduced by a minimum of 38%

Biosolids Data 1st Quarter

CARMEL AREA WASTEWATER DISTRICT

Annual Biosolids Monitoring Report

Period: April 2023-June 20223

Sample Date: 18-Apr-23

Name POLLUTANTS	Concentration (mg/kg) Dry Weight unless indicated	EPA 503 pollution limits for land application	
		Pollutant Concentrations (40 CFR 503.13) (monthly avg.)	Ceiling Concentrations (40 CFR 503.13) (daily maximum)
Antimony	ND		
Arsenic	ND	41 mg/Kg	75 mg/Kg
Barium	303.0		
Beryllium	ND		
Boron	39.2		
Cadmium	3.2	39 mg/Kg	85 mg/Kg
Chromium	30.8		
Cobalt	1.3		
Copper	686.0	1500 mg/Kg	4300 mg/kg
Lead	41.3	300 mg/Kg	840 mg/kg
Molybdenum	22.2		75 mg/kg
Nickel	30.4	420 Mg/Kg	420 mg/Kg
Phosphorus	23,400		
Selenium	12.1	100 mg/Kg	100 mg/Kg
Silver	ND		
Thallium	ND		
Vanadium	20.0		
Zinc	1080.0	2800 mg/Kg	7500 mg/Kg
Ammonia Nitrogen	5630		
Cyanide, Total	ND		
Nitrate Nitrogen	ND		
Nitrogen, Total Kjeldahl	38,200		
pH	7.75		
% Solids	23.0%		
Mercury	0.2	17 mg/Kg	57 mg/Kg
Grease/Oil	ND		
Hex Chromium	ND		

Pathogen Reduction (40 CFR 503.32)

Class B - (PSRP) Anaerobic Digestion at 95 F for minimum of 15 days

Vector Attraction Reduction (40 CFR 503.33)

Option 1 - VS reduced by a minimum of 38%

Biosolids Data 2nd Quarter

CARMEL AREA WASTEWATER DISTRICT

Annual Biosolids Monitoring Report

Period: July 2023 - September 2023

Sample Date: 11-Jul-23

Name POLLUTANTS	Concentration (mg/kg) Dry Weight unless indicated	EPA 503 pollution limits for land application	
		Pollutant Concentrations (40 CFR 503.13) (monthly avg.)	Ceiling Concentrations (40 CFR 503.13) (daily maximum)
Antimony	ND		
Arsenic	ND	41 mg/Kg	75 mg/Kg
Barium	68.1		
Beryllium	0.6		
Boron	12.9		
Cadmium	0.5	39 mg/Kg	85 mg/Kg
Chromium	5.0		
Cobalt	ND		
Copper	195.0	1500 mg/Kg	4300 mg/kg
Lead	8.2	300 mg/Kg	840 mg/kg
Molybdenum	5.7		75 mg\kg
Nickel	5.9	420 Mg/Kg	420 mg/Kg
Phosphorus	10,000		
Selenium	2.1	100 mg/Kg	100 mg/Kg
Silver	ND		
Thallium	ND		
Vanadium	1.9		
Zinc	325.0	2800 mg/Kg	7500 mg/Kg
Ammonia Nitrogen	5510		
Cyanide, Total	0.11		
Nitrate Nitrogen	ND		
Nitrogen, Total Kjeldahl	2,870		
pH	6.7		
% Solids	23.8%		
Mercury	0.2	17 mg/Kg	57 mg/Kg
Grease/Oil	560		
Hex Chromium	ND		

Pathogen Reduction (40 CFR 503.32)

Class B - (PSRP) Anaerobic Digestion at 95 F for minimum of 15 days

Vector Attraction Reduction (40 CFR 503.33)

Option 1 - VS reduced by a minimum of 38%

Biosolids Data 3rd Quarter

CARMEL AREA WASTEWATER DISTRICT

Annual Biosolids Monitoring Report

Period: October 2023 - December 2023

Sample Date: 10-Oct-23

Name POLLUTANTS	Concentration (mg/kg) Dry Weight unless indicated	EPA 503 pollution limits for land application	
		Pollutant Concentrations (40 CFR 503.13) (monthly avg.)	Ceiling Concentrations (40 CFR 503.13) (daily maximum)
Antimony	ND		
Arsenic	ND	41 mg/Kg	75 mg/Kg
Barium	57.7		
Beryllium	0.5		
Boron	8.8		
Cadmium	0.4	39 mg/Kg	85 mg/Kg
Chromium	2.1		
Cobalt	ND		
Copper	135.0	1500 mg/Kg	4300 mg/kg
Lead	3.9	300 mg/Kg	840 mg/kg
Molybdenum	5.6		75 mg\kg
Nickel	2.8	420 Mg/Kg	420 mg/Kg
Phosphorus	6,920		
Selenium	ND	100 mg/Kg	100 mg/Kg
Silver	14.1		
Thallium	ND		
Vanadium	1.3		
Zinc	302.0	2800 mg/Kg	7500 mg/Kg
Ammonia Nitrogen	1150		
Cyanide, Total	ND		
Nitrate Nitrogen	ND		
Nitrogen, Total Kjeldahl	10,600		
pH	6.89		
% Solids	20.0%		
Mercury	0.9	17 mg/Kg	57 mg/Kg
Grease/Oil	600		
Hex Chromium	ND		

Pathogen Reduction (40 CFR 503.32)

Class B - (PSRP) Anaerobic Digestion at 95 F for minimum of 15 days

Vector Attraction Reduction (40 CFR 503.33)

Option 1 - VS reduced by a minimum of 38%

Biosolids Data 4th Quarter

Month	Detention Time (days)	Temperature (F)	Volatile Solids Reduction (%)
Jan	32	100.0	52
Feb	27	89.4	51
Mar	25	100.5	56
Apr	22	102.9	61
May	25	101.3	59
Jun	24	100.5	64
Jul	25	103.3	57
Aug	24	100.1	54
Sept	24	103.5	66
Oct	26	104.2	63
Nov	23	102.0	62
Dec	28	100.2	69

Biosolids Data Class B Requirements

Section H: Pretreatment

1

Influent Characteristics	Date	Result	Date	Result	Units
Arsenic	1/25/2023	1.32	7/11/2023	1.03	ug/L
Cadmium	1/25/2023	4.3	7/11/2023	0.233	ug/L
Total Chromium	1/25/2023	3.37	7/11/2023	1.01	ug/L
Lead	1/25/2023	2.14	7/11/2023	1.48	ug/L
Copper	1/25/2023	55.8	7/11/2023	134	mg/L
Mercury	1/25/2023	ND	7/11/2023	0.016	ug/L
Nickel	1/25/2023	7.26	7/11/2023	4.7	ug/L
Silver	1/25/2023	ND	7/11/2023	ND	ug/L
Zinc	1/25/2023	256	7/11/2023	340	ug/L

2

Number of Inspections Performed:
 Pretreatment Inspections annual-(112)

Number of Enforcement
 Actions:

Notice of Violations of the Pretreatment Ordinance – (2)

- 3** Number of Major Industry Contributors- None (0)
- 4** All New dischargers- (5)
 - Class III (5)
 - Class IV (0)
- 5** All New Dischargers constitute a Major Industry- None (0)
- 6** Manpower and funds to run Source Control Program
 - Environmental Compliance Supervisor (1)
 - Environmental Compliance Inspectors (2)
 - Funds for Source Control Program are from User Fees (Connection Permit, Construction Fees, and Source Control Application/ Permit, and Source Control Fines).

Type	Application	Business	Cost	Fines	Total by Type
Class 3	Permit	5	\$150.00		\$750.00
Class 4	Permit	101	\$150.00		\$15,150.00
Commercial Other (CMO)	Permit	11	\$150.00		\$1,650.00
Notice of Violation (NOV)		2	\$75.00	2	\$150.00
				Grand Total	\$17,700.00

A new Carmel Area Wastewater District Pretreatment Ordinance 2022-02 was adopted on March 31, 2022, and in effect on April 22, 2022.

Section I: Salt and Nutrient Management Plan

This facility does not need a salt and nutrient management plan. – Not Applicable.

Section J: Collection System Management Plan

CAWD Collections Annual Report For 2023

This report provides an overall summary of system wide cleaning and CCTV activities, construction, and Sewer Spill information for the year 2023.

Cleaning Activity: The collection crew maintains 408,581 feet of gravity sewer lines and 21,600 feet of force mains in the district. During 2023, staff cleaned the entire system in a little over 8 months. The cleaning methods used were hydro cleaning, flushing and root foaming.

Activity	Feet Cleaned
Cleaning - Jetting	541,219 ft.
High Frequency Lines	53,217ft.
Root Foaming	34,584 ft.
Flushing	1909 ft.
Total	630,929 ft.

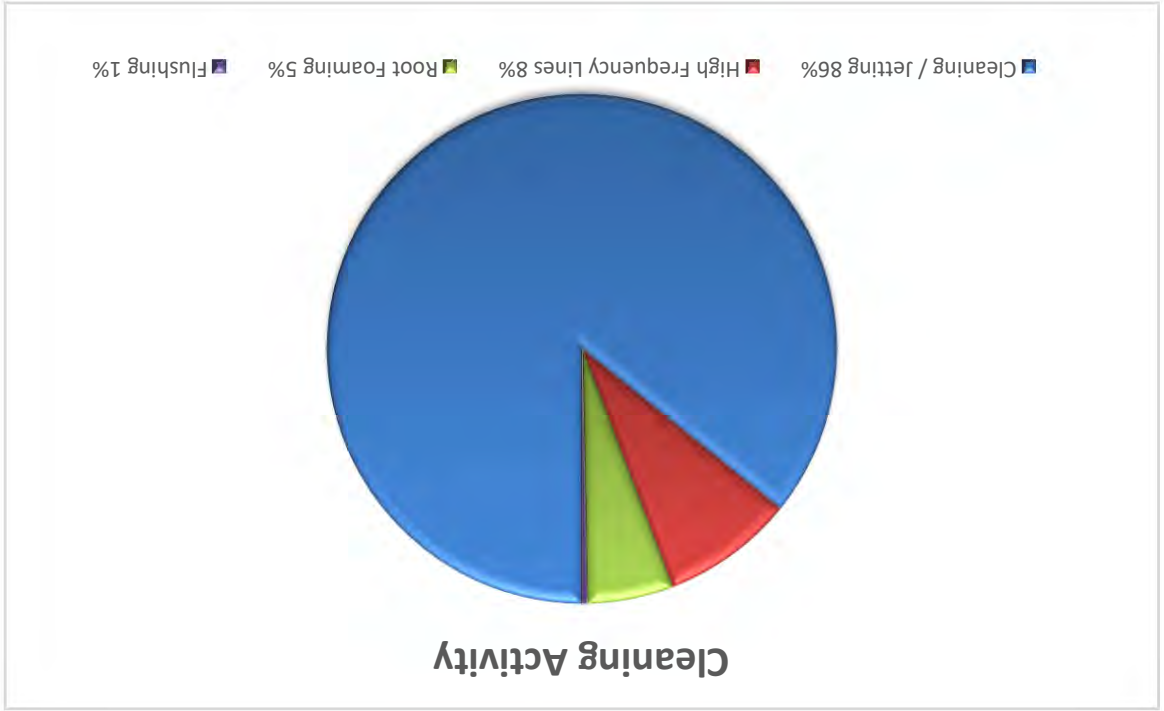

Maintenance Activity: Collection crews responded to 71 service calls in 2023, with private lateral problems being most of the calls. The remaining calls were for odor complaints, pump station related problems, backed up plumbing, and rattling manholes. There were 2522 Underground Service Alerts calls for marking sewer locations for 2023. Collection crews were able to CCTV inspect 7,697 feet of sewer line. The district's root foaming program treated 34,584 feet of problematic lines with roots.

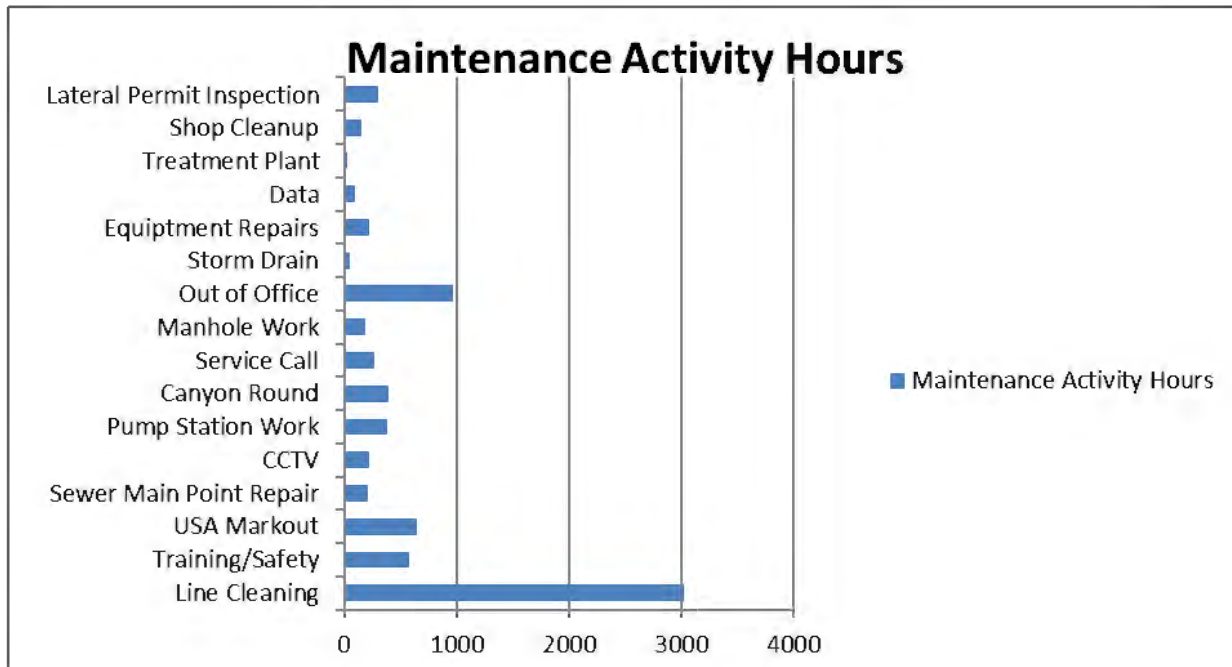

Construction Activity

Spot Repair Project:

- In 2023 CAWD awarded a contractor the bid for 16 spot repairs in the district’s system. All spot repairs completed by 6/30/2023.

Emergency Repairs:

- 1/6/2023: Plumbing Contractor made an emergency repair on line segment O920-O921 due to a developing sink hole.
- 1/8/2023: Paving Contractor made an emergency repair along Scenic Dr. West of the Carmel River Lagoon due to heavy storm swells that eroded the cliff side along Scenic Dr. Flow for this street were reversed and sent to Valley Way where they were reconnected to the existing infrastructure.
- 1/18/2023: Underground Contractor made first attempt to install new sewer main along Lorca Ln. Effort abandoned due to high ground water table. The second attempt in dryer time of year was successful.

Manhole Lining Activity:

- Manhole lining demo at MH O809

Other Notable Activity:

In 2019, a new ordinance was passed that required the PSL (Private Sewer Lateral) to be inspected and repaired as needed at the sale of the property, a remodel over \$50,000.00 USD, or a violation of the ordinance. (Ordinance 2019-1.)

Year	PSL Compliance Certificate issued
2019	105
2020	335
2021	300
2022	261
2023	196

There were 222 lateral permit inspections and 197 PSL certificate of compliance certificates issued in 2023. Since the adoption of Ordinance 2019-1 the District has inspected and issued 1196 Private Sewer Lateral Certificate of Compliance out of 6982 possible connections which represents 17% of the districts connections that have been inspected.

The Collections Department attended all the required safety training in 2023. Staff attended both the CWEA Annual conference and the CSRMA Sewer Summit online. In 2023, Collections staff cleaned the storm drain interceptors and catchment ponds for the city of Carmel by the Sea in both the Spring and Fall.

SSO Summary:

DATE	SPILL LOCATION	GALLONS SPILLED	GALLONS RECOVERED	CAUSE OF SPILL
1/17/2023	25797 Morse Dr	5419	18	Roots
2/16/2023	2925 Ribera Rd.	506	28	Grit/Debris
3/17/2023	3NW of 9 th on Casanova	108	5	Roots / debris
4/07/2023	SW C/O San Carlos & 4th	1301	0	Roots / debris
4/12/2023	3629 Oliver Rd & Hwy 1	361	171	Debris & Damage
4/25/2023	25950 Canada Dr	48,269	5234	PG&E pole thru mainline
5/11/2023	24668 Upper Trail	222	0	Roots
6/2/2023	ARV Vault 17A Hwy 1	357	0	Broken FM wye
9/26/2023	127' DS of MH Q763	44,159	0	Main line swept away
12/16/2023	MH R732 on Hwy 1 & Oliver	3	3	Liner Failure

SSO#1 Spill appeared from the clean out of 25797 Morse Dr. Spill caused by partial root blockage growing in at drop hole at MH Q763.

SSO #2 occurred at manhole T603, in an easement located behind 2925 Ribera Rd in Carmel Meadows. This manhole has a history of overflows caused by grit / debris that collects in the main line due to a large sag. This line segment is scheduled to be replaced during the Carmel Meadows Replacement Project (Project ID #19-03).

SSO #3 occurred from private lateral clean out and SRV in middle of driveway. Root intrusion from lateral tap created partial blockage that backed up and daylighted at private lateral clean out & SRV.

SSO #4 Spill appeared from the C/O at the Fireplace Inn, SW corner of San Carlos & 4th, root intrusion was the cause.

SSO #5 occurred DS of MH R737, historic video shows damage from boulders being dumped on top of pipe. Rags hung up on broken pieces of pipe causing blockage.

SSO #6 Spill appeared upstream of MH Q905. Caused by PG&E subcontractor who drove a replacement pole through sewer main during storms in front of 25930 Canada Drive.

SSO #7 Spill occurred from MH N750. Caused by root blockage in the main sewer line.

SSO #8 Spill occurred on west side of HWY 1 N. of Point Lobos entrance at CAWD ARV Vault 17A. Broken Wye was the cause of spill.

SSO #9 Spill occurred 127' downstream of MHQ763. Concrete debris uphill caused the hill to slide taking out repair in mainline made 10yrs prior. Temporary repair was made, and a permanent repair was made on 11/29/2023.

SSO# 10 Spill occurred at MH R732 between the fog line and the gutter to the west on Hwy 1. Cause of spill was CIPP liner in VCP pipe failed.

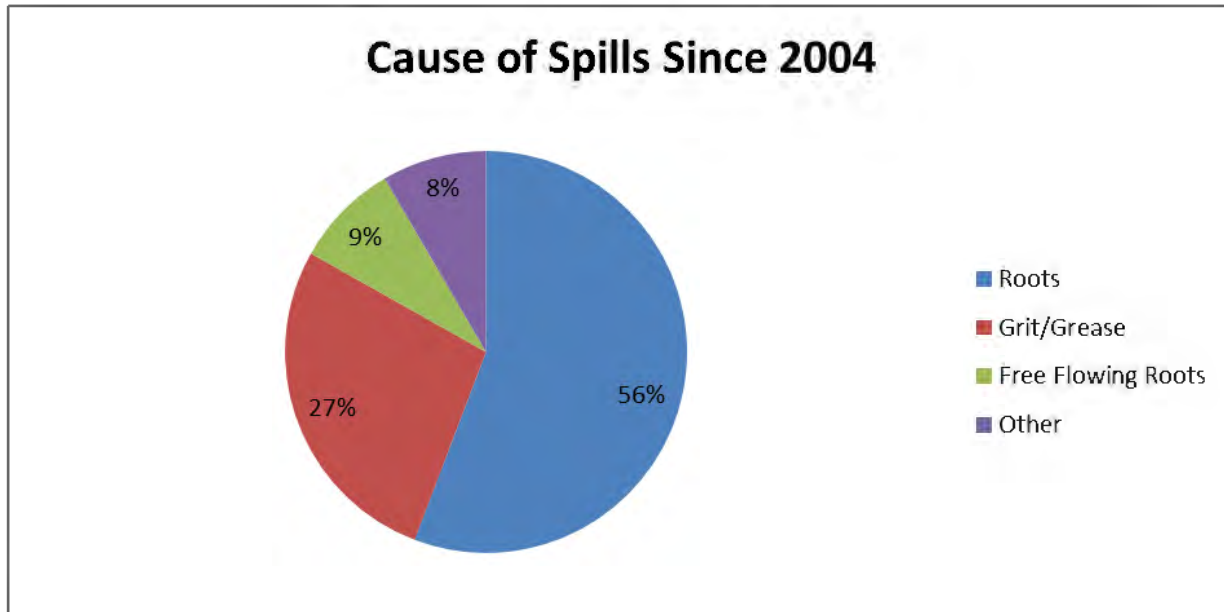
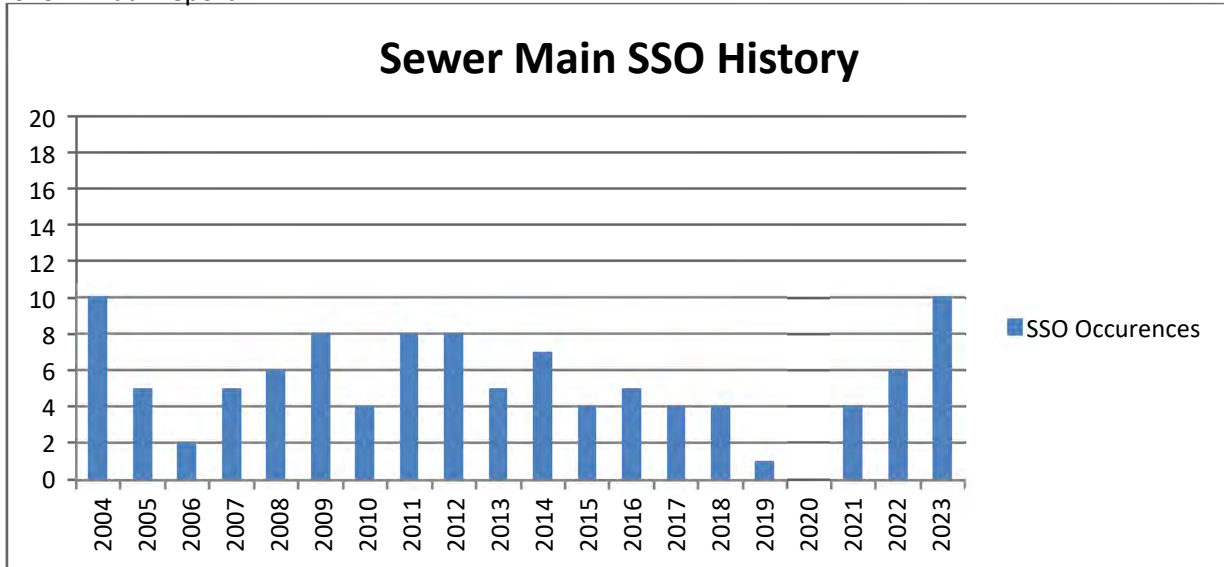

Section K: Mercury Seals

This facility does not use Mercury Seals – Not Applicable.

A map of all 2023 spill locations is attached to this report.

Spill Map 2023

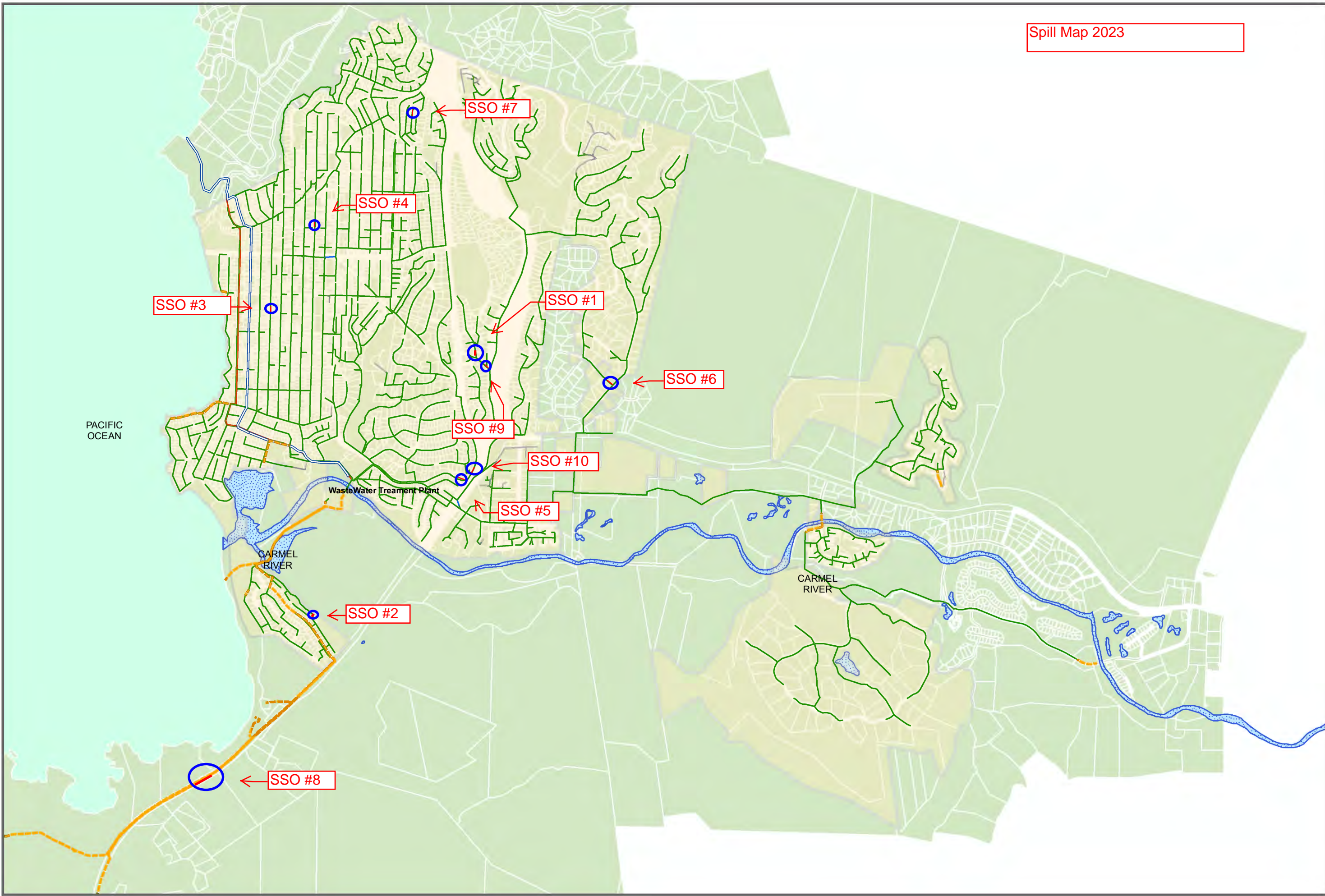

- Legend**
- ForceMains
 - Sewer Pipes**
 - Gravity
 - Private
 - PBCSD
 - Forcemain
 - FM Outfall
 - OFW
 - Reclamation
 - Service Area
 - County Parcels

Carmel Area Wastewater District
Sanitary Sewer System Inventory



Created by
RedZone Robotics
Revised 10/2013

Section L: Figures

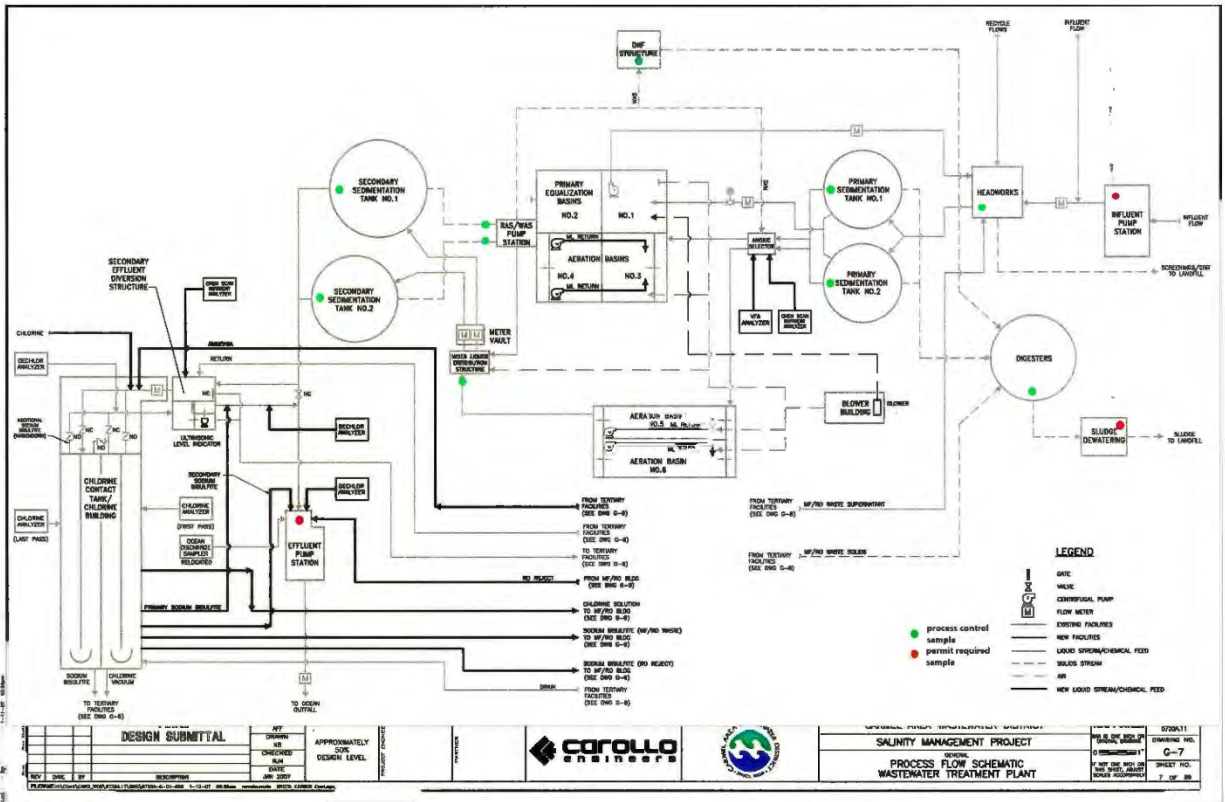

CAWD Plant Flow Schematic

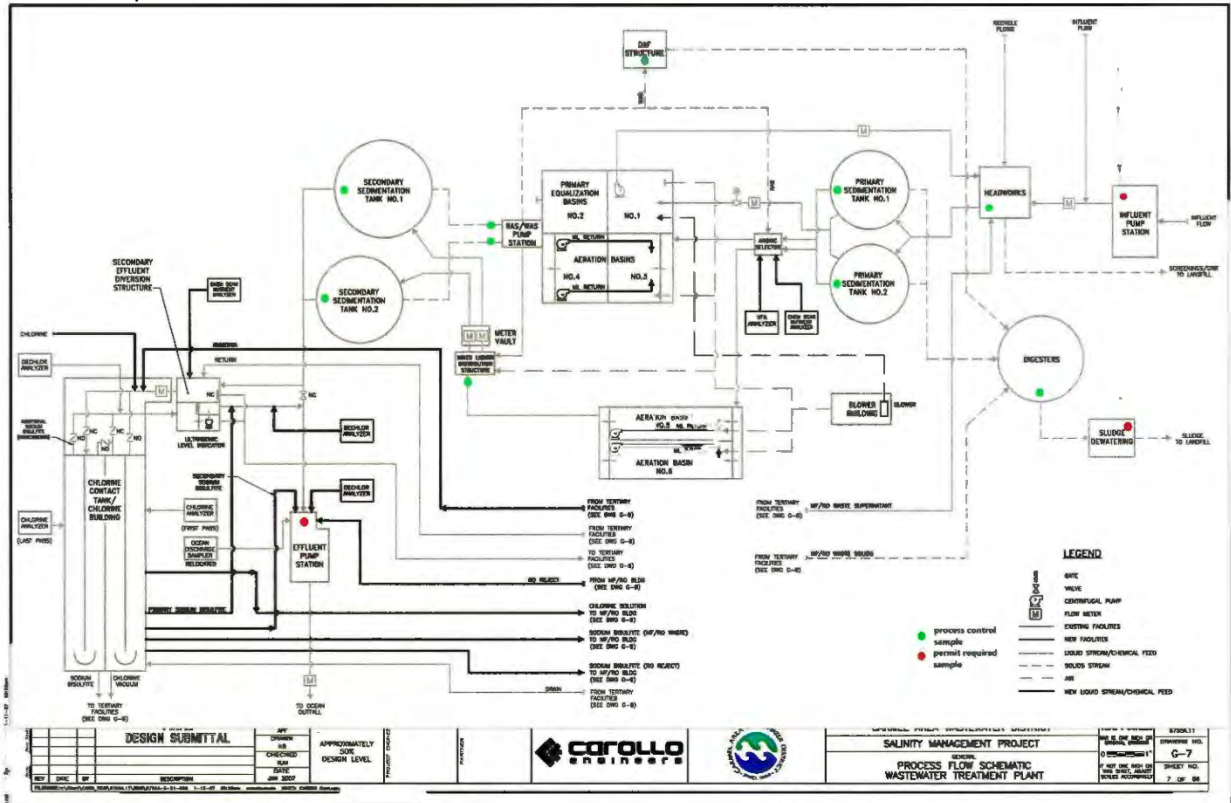

CAWD PLANT SAMPLING LOCATIONS



CAWD Building and Storage Locations

Lab Reports

This facility's Monitoring and Reporting Program requirements do not have specific annual monitoring.

Carmel Area Wastewater District
Tertiary WDR Order 93-72 Annual Report 2023

California Regional Water Quality Control Board
Central Coast Region
895 Aerovista Place, Suite 101
San Luis Obispo, CA 93401

Document
Date: 1/31/2024

Submit this Self Monitoring Report to: centralcoast@waterboards.ca.gov

FACILITY NAME: Carmel Area Wastewater District Wastewater Treatment Plant

FACILITY ADDRESS: 26900 State Route One
Carmel, CA 93923

CONTACT PERSON: Edward Waggoner

JOB TITLE: Operations Superintendent

PHONE NUMBER: (831) 257-0437

EMAIL: waggoner@cawd.org

WDR ORDER (Permit) Number: 93-72

WDID NUMBER: 3 270101001

PERMITTED FLOW (see facility WDR Permit): 1,800,000 gpd

AVERAGE WASTEWATER FLOW (over monitoring period): 819,000 * gpd

TYPE OF REPORT: Annual Semiannual Quarterly
 Monthly Other: _____

REPORTING PERIOD: 01/01/2023 TO 12/31/2023

MONITORING PERFORMED DURING THIS PERIOD (check all that apply):

Groundwater Lab Reports Recycled Water
 Treatment System Effluent Solids Disposal Disposal Area
 Treatment System Influent Water Supply Use Area
 Source Water Monitoring Other: _____

Violation(s) during this monitoring period? YES NO

Parameter(s) in Violation: Pursuant to Standard Provisions¹ see footnote on next page, monitoring reports must contain date of violation, explanation of cause and corrective actions planned or taken to prevent recurrence. Please include parameter(s) and date(s) of violation in space provided below. If space is insufficient, include an independent discussion containing explanation of cause and corrective action within monitoring report.

Discharger Comments:

* Influent Plant Flow, note CAWD has two separate discharge permits R3-2014-0012 for ocean discharge and #93-72 for reclamation discharge. Average GPD ocean discharge average was 618,000 GPD for 2023, and average daily reclamation discharge to golf course irrigation storage was 819,000 GPD for 2023.

Submit this self-monitoring report to centralcoast@waterboards.ca.gov in searchable PDF format. Include attached cover sheet and signature page. DO NOT submit via US mail.

In accordance with the Standard Provisions and Reporting Requirements, I certify under penalty of law that this document and all attachments were prepared under my direction or supervision following a system designed to assure that qualified personnel properly gather and evaluate the information submitted. Based on my knowledge of the person(s) who manage the system, or those directly responsible for data gathering, the information submitted is, to the best of my knowledge and belief, true, accurate, and complete. I am aware that there are significant penalties for submitting false information, including the possibility of fine and imprisonment.

Print Name: Edward Waggoner Title: Operations Superintendent

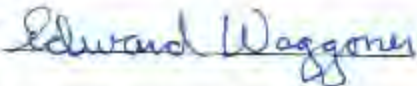
Signature:^{*}  Date: 1/31/2024

*All reports shall be signed by one of the following:

- a. For a corporation: by a principle executive officer of at least the level of vice president.
- b. For a partnership or sole proprietorship: by a general partner or the proprietor, respectively.
- c. For a public agency: by either a principle executive officer or ranking elected official.
- d. For a LLC: either a member or manager given signing authority by the operating agreement of LLC.
- e. a "duly authorized representative" of one of the above.

Electronic access to Standard Provisions: https://www.waterboards.ca.gov/centralcoast/board%20decisions/docs/wdr_standard_provisions_2013.pdf

Table of Contents

Coversheet	- 1 -
Table of Contents	- 3 -
Introduction	- 4 -
Section A: Data Tables and Graphs	- 12 -
Section B: Compliance and Performance	- 17 -
Section C: Flow Evaluation	- 18 -
Section D: Operator Certification	- 20 -
Section E: Operation and Maintenance	- 21 -
Section F: Laboratory Information	- 22 -
Section G: Sludge Management	- 22 -
Section H: Pretreatment	- 22 -
Section I: Salt and Nutrient Management Plan	- 22 -
Section J: Collection System Management Plan	- 22 -
Section K: Mercury Seals	- 23 -
Section L: Figures	- 23 -
Lab Reports	- 25 -

Introduction

Facility Objective: Carmel Area Wastewater District protects public health and enhances the environment by collecting and treating wastewater while recycling valuable resources for golf course irrigation in the Carmel Bay region.

Treatment Technologies Used

The CAWD Wastewater Treatment Plant (WWTP) has a permitted capacity of 3.0 million gallons per day (MGD) of dry weather flow. Current average dry weather flow (ADWF) is approximately 1.1 MGD which represents 37% of the permitted capacity. Of the 1.1 MGD, approximately two-thirds are from CAWD customers, and the remaining one-third is from Pebble Beach Community Service District customers.

During large storm events the inflows can increase up to eight times the dry-weather rates. This requires the plant equipment and processes designed to manage large hydraulic loads during the winter months.

Influent Pumping

The purpose of influent pumping is to lift the incoming untreated sewage from the terminus of the interceptor sewers up and into the headworks from where the sewage can flow by gravity through the other treatment processes. Approximately 97% of the influent sewage is pumped at the influent pump station; the remaining 3% is discharged directly into the headworks from the Calle La Cruz pump station in the Carmel Meadows subdivision.

During power outages, a dual standby generator system automatically provides backup power to all four influent pumps. There is always at least a 7-day supply of fuel onsite to power the standby generator.

Headworks

The headworks structure, together with the adjacent influent manhole, contains all the pretreatment processes of the plant. Unit processes located within the headworks are influent flow measuring, automatic bar screening, grit removal and washing.

The automatic bar screen removes rags and other large solids from the raw sewage and into a hopper which stores the screenings until they are removed and disposed of at the landfill.

Grit (i.e., sand, coffee grounds, other inorganic materials) is removed from the raw sewage by means of settling in an agitated tank. The agitation keeps the lighter organic solids in suspension and allows the heavier solids to drop out and be removed by pumping the contents from the bottom of the tank into a grit classifier and washer. The grit washer further separates the heavier grit particles from the lighter organic matter and the grit is then disposed of into a bin for disposal at the landfill.

Primary Sedimentation Tanks

The Primary Clari-Thickener tanks remove the majority of suspended solids from the wastewater by gravity settling. CAWD has two primary Clari-Thickener tanks for redundancy. The Clari-Thickener combines the feature of a Primary clarifier for removing settleable solids and floating matter (scum) and a thickening well for concentrating sludge prior to withdrawal for further treatment. Each tank has a mechanical scraper which rotates around the sloping bottom and pushes settled sludge to a sludge thickening zone and a sludge sump. Sludge is withdrawn from the tanks and is transported to the anaerobic digestion tanks. Floating matter is mechanically skimmed into collecting hoppers and is also transported to the anaerobic digestion tanks.

The primary sedimentation process is a physical process utilizing gravitational forces. Settleable and suspended solids, which are the major components of sludge and are heavier than water, settle out of the sewage along with any grit carryover from the headworks. Scum, which is lighter than water, floats to the surface and is removed by skimming. Approximately 60 to 65 percent of the suspended solids will be removed by gravitational forces as part of primary sedimentation.

Effluent from the primary sedimentation tanks overflows into double sided circumferential launders and then flows into either the primary equalization system or the aeration basins.

Primary Equalization

The flow equalization basins are designed to reduce flow to the treatment plant during daytime periods of high influent flow. Wastewater stored in the flow equalization basins is reintroduced into the normal wastewater stream at the option of the operator in order to maintain operation of the Reclamation facility when influent flows are low. This operation also ensures that influent flow can be prioritized for reclamation uses over discharge to the outfall.

The reintroduced flow is pumped back to the Headworks.

Diffusers are located in the basins to prevent stored wastewater from becoming septic.

Anoxic Selector

The Anoxic Selector mixes the return activated sludge (RAS) from the secondary clarifiers with effluent from the primary clarifiers and equally distributes the combined flow to Aeration Basins No. 4, 5, and 6.

Aeration (Biological Activated Sludge Process)

The aeration structures (basins) are designed to promote the growth of helpful bacteria organisms which consume the nutrients in the sewage. This is called the "activated sludge" process. By injecting substantial amounts of oxygenated air, these bacteria thrive and consume the biochemical oxygen demand, ammonia, carbohydrates, fats, along with other materials in the sewage and convert it into bacterial mass or "sludge" for removal in the Secondary Sedimentation Tanks.

The aeration structures can hold about 1.15 million gallons total divided into three separate basins. The helpful bacteria population is maintained in the basins by returning a portion of the sludge separated out of the water downstream in the Secondary Sedimentation Tanks back to the front of the Aeration Basins. This allows the helpful bacteria to live out their life cycle in the treatment process, all the while providing a beneficial service to the treatment process.

CAWD utilizes A2O process which creates different zones in the aeration basins, some with oxygen (aerobic), and some without oxygen (anoxic/anaerobic). The different zones allow for selecting the types of bacteria that are the most beneficial and to enhance the nitrification process.

Aeration in each basin is accomplished by air blowers feeding fine bubble diffusers at the bottom of each basin. Air flow is regulated by automatic dissolved oxygen (DO) control systems.

Mixed Liquor Distribution Structure

The Mixed Liquor Distribution Structure receives and combines the flows exiting the Aeration Basins. Combined flow is then gravity-fed to the Secondary Clarifiers. Two gates are used to control flow to each of the two Secondary Clarifiers.

Secondary Sedimentation Tanks

The Secondary Sedimentation Tanks are similar to the Primary Sedimentation Tanks except they are designed to remove lighter suspended solids. There are two tanks, each equipped with rotating mechanical sludge and scum collectors. The effluent from the Aeration Basins enters each tank through the bottom, rises up through the center column, and then is distributed into the sedimentation zone. Settled sludge is removed from the tank and clean water flows over weirs to the next step in the process (disinfection). The sludge is pumped back to the Aeration process to maintain the helpful microorganism population or wasted to the solid's treatment process. Scum is collected from the surface of the wastewater in each tank and returned to a sump in the Aeration Structure, from which it is then pumped to the solid's treatment process.

The clean water coming out of the Secondary Sedimentation Tanks is clear and has exceptionally low concentrations of bacteria and ammonia. Disinfection/Dechlorination is next and is the final treatment step before this water is sent to the Reclamation Facility or to the Ocean.

Secondary Effluent Diversion Structure

The Secondary Effluent Diversion Structure serves two purposes:

1. Aiding in downstream disinfection - Secondary flow enters the structure where an injection of liquid Sodium Hypochlorite and aqueous ammonia is used for disinfection leading into the chlorine contact channels at the Chlorination Building. When ammonia is introduced under the appropriate conditions, it reacts with hypochlorous acid to produce monochloramine. Monochloramine is used as a disinfectant rather than free chlorine because free chlorine is

detrimental to the Reverse Osmosis membranes at the Reclamation Facility. The amount of chlorine and ammonia required to produce monochloramine is based on the ideal weight ratio of 5:1. The desired ratio is controlled, monitored, and driven by programmable logic controllers located in the Hypochlorite/Sodium Bisulfite Building and the ammonia injection system at the Tertiary Facilities.

2. Flow Management – The Secondary Diversion Structure also receives the effluent flow from the Chlorination Building and either directs the flow to the holding basin at the Tertiary Building prior to reclamation or to the Outfall Building for ocean discharge.

Disinfection/Dechlorination

The last step to clean the water is disinfection/dechlorination. Disinfection is accomplished using liquid Sodium Hypochlorite (i.e., bleach) which kills bacteria and deactivates viruses and protozoa that may be harmful to human health. A small concentration of chlorine is maintained in the water for about 2 hours to make sure all of the harmful pathogens are killed or deactivated. The residual chlorine is then removed using liquid sodium bisulfite. At this point, the water is safe to send out to the ocean, or it is sent to the Reclamation Facility for further treatment to allow the water to be reused for irrigating golf courses in Pebble Beach.

Treated Water Pump Station and Ocean Outfall

The treated water is pumped to Carmel Bay, or it is treated further in the Reclamation Facility and sent to Pebble Beach golf courses. The water that is pumped to the ocean the majority of the year is concentrated brine which is the water left after treatment through the Reverse Osmosis (RO) system in the Reclamation Facility. The RO system removes dissolved solids (i.e., salts), which are collected in the brine. This brine is then pumped to the ocean. The salt content of the brine is lower than the salt content in the ocean and so there are no detrimental effects associated with the brine. During winter storms, when flows increase, a portion of the treated water is not sent to the Reclamation Facility and goes directly out of the outfall.

A pipeline carries the treated water or brine to the ocean. The existing ocean outfall is a 24-inch diameter, concrete encased pipe with 10 diffuser ports along the pipe. Each port has a rubber “duckbill” type valve to prevent debris from entering the outfall pipe during periods of low flow. The diffusers are designed to quickly disperse the treated water into the receiving water so that there is no environmental degradation around the outfall.

Solids Treatment and Disposal

There are several individual processes that are utilized to manage and treat the solids generated from the wastewater treatment process. These are: Sludge Thickening, Anaerobic Digestion, and Dewatering.

Sludge Thickening

The lighter sludge generated by the Secondary Sedimentation Tanks and the Microfiltration Membranes (Reclamation) are sent to the Dissolved Air Flotation Sludge Thickener to thicken the sludge before sending it to the Anaerobic Digesters.

Thickening is achieved by adding fine air bubbles into a tank containing the light sludge. The air lifts the sludge particles to the surface so they can coalesce at the surface and be skimmed off in a more concentrated/thick state. This thicker sludge that is collected is sent to the Anaerobic Digesters. The liquid that the solids are separated from is returned to the Headworks to be treated again through the plant.

This is not required for the sludge from the Primary Sedimentation Tanks which is already thick enough to send straight to the digesters.

Anaerobic Digestion

The solids treatment process takes sludge and other solids and places them in an anaerobic digester where the sludge is kept at about 95 degrees and anaerobic bacteria are utilized to stabilize the sludge and remove pathogens. The detention time in the anaerobic digesters is maintained at around 20 days or more.

A byproduct of the anaerobic digestion process is methane gas. CAWD uses the methane produced to generate electricity using two microturbines. The microturbines can produce about 15% of the power demand required by the wastewater treatment plant (not including the Reclamation Facility).

After the solids have been stabilized sufficiently by the digestion process the solids are held in a holding tank before they are sent to the dewatering equipment.

Dewatering and Land Application

Dewatering is a physical/mechanical process used to reduce the moisture in digested sludge (biosolids). There are reasons for dewatering sludge. In general, it is more economical to dispose of the dewatered sludge than it is to pump or haul liquid sludge to disposal sites because by reducing the moisture content, the sludge volume and weight are reduced.

The CAWD plant uses a belt filter press or a screw press to dewater the digested sludge. This equipment presses out the moisture from the sludge to create a dry material that is essentially dirt that can be land applied.

The dewatered sludge is hauled by truck to Kern County where it is used as a compost amendment for nonfood crops.

Reclamation Plant

Overview

On an average day about 90% of the water that comes into the CAWD wastewater treatment plant is reclaimed and sent to Pebble Beach golf courses for irrigation. CAWD owns the Reclamation Treatment Facility which is a part of a larger project including storage and conveyance infrastructure that was created in partnership with the Pebble Beach Community Services District (PBCSD), and the Monterey Peninsula Water Management District (MPWMD). Collectively the Reclamation Project offsets about 1,000-acre feet per year of potable water that would otherwise be drawn from the Carmel River aquifer. This 1,000-acre feet per year is an important part of the water supply portfolio for the greater Monterey Peninsula, Seaside, and Carmel Area. For reference, the total annual water taken from the Carmel River is about 3,000-acre feet per year.

The original reclamation plant, constructed in 1994, consisted of a large storage basin, and a sand filtration process to remove fine particulates from the water to meet California recycled water treatment requirements.

In 2008 a more advanced treatment facility was added to treat the water to an even higher quality. The new facility contains microfiltration (MF) and reverse osmosis (RO) membranes to filter out dissolved ions (salts) from the water.

The MF/RO system has a capacity to produce 1.8 million gallons per day (MGD) of recycled wastewater. Based on current average flows, the average output of reclaimed water is about 1.0 MGD.

Pretreatment of Secondary Effluent

Secondary effluent is diverted by gravity from the secondary process flow stream to the tertiary plant flow equalization basin. The flow equalization basin provides adequate storage of secondary effluent to allow the reclamation facilities to operate at full capacity during nighttime periods of low secondary effluent flow. The tertiary facilities

Tertiary influent is pumped to the coagulant rapid mix chamber for addition of Cerium Chloride for phosphorus and colloidal solids removal. The coagulated flow is then routed to one or two two-stage flocculation chambers. The flocculated flow is divided to flow through four continuous backwash filters. Feed water is passed upwards through the sand bed, exiting from the top of the filter media as clean water. While at the same time, sand is continuously moved from the bottom of the filter bed, cleaned by air scouring, and returned to the top of the filter.

Following filtration, the clean water is pumped through strainers and into the Microfiltration system.

Microfiltration (MF)

Microfiltration membranes filter exceedingly small particles out of the water (smaller than the diameter of a human hair). The membranes can physically block individual microorganisms such as bacteria from passing through.

Due to the small pore sizes in the membranes the microfiltration membranes provide a slightly better product than traditional filters such as sand filters. Microfiltration provides pre-filtration prior to the water being sent to the Reverse Osmosis System to remove dissolved ions.

The microfiltration membranes are submerged in a basin that is filled with the treated water from the wastewater treatment plant. The water is pulled through thousands of small straw-like membranes with microscopic pores to filter the water. The dirty water is left in the basin to be backwashed and removed to the solid's treatment process in the wastewater treatment plant.

Reverse Osmosis (RO)

Reverse osmosis membranes physically remove even smaller particles than MF. The RO membranes remove ions at the atomic level (i.e., ions dissolved in the water). This also provides physical removal of viruses in addition to further removal of bacteria in the water.

The water that does not pass through the RO membranes becomes a concentrated brine that contains all of the dissolved ions, and cells that are rejected by the membranes. This brine is disinfected and dechlorinated to deactivate and kill viruses and bacteria before the water is sent to the ocean outfall for disposal.

Disinfection

Similar to drinking water the state requires that recycled water be disinfected prior to distribution, and that a chlorine residual be maintained in the distribution system to mitigate regrowth of harmful bacteria in the piping.

CAWD utilizes sodium hypochlorite and aqueous ammonia to create chloramines for disinfection and to maintain a disinfectant residual in the distribution system. Chloramines are also commonly used in drinking water systems because they have less carcinogen developing properties than free chlorine.

Conveyance

CAWD pumps the water from the treatment plant to Pebble Beach using vertical turbine pumps. The water must travel about 5 miles and up in elevation about 250 feet to get to the Pebble Beach storage infrastructure.

Targeted Removals of Main Pollutants

- BOD target removal 90% of influent average BOD per month.
- TSS target removal 90% of influent average TSS per month.

Overview of Any Liquid or Solid Waste Produced

- Liquids see Section C Flow Evaluation
- Solid Waste see Section G Sludge Management

Upgrades Since the 2014 Permit was Issued

New Structures:

- Anaerobic Digester #2 -450,000 gallons.
- Control Building for Anaerobic Digester #2 with future space for cogeneration equipment.
- Ferric Chloride Storage and Dosing for Sulfide control in digesters.
- Sodium Hypochlorite/Sodium Bisulfite storage 9,000 gallons of each product, new chemical dosing pumps (with redundancy).
- Storm water pump station to retain all storm water collected on facility site and treated in the plant flow stream.
- Waste gas burner to meet the stricter clean air requirements.
- 2023 new sludge holding tank, replacement of 1938 sludge digester. Installed new sludge mixing system in new sludge holding tank and instrumentation.

Existing Structures that Received Upgrades

- Dewatering Building received new screw-press and polymer systems.
- Blower Building received new energy blower and air diffuser membranes.
- Dissolved Air Floatation Thickener received new solids collector and drive, sludge pumps, and air compression systems.
- Operations Building received new Motor Control Center, Programmable Logical (PLC) Computer and Supervisory Control and Data Acquisition System (SCADA).
- Fresh Water System (#1 water system) Air Gap System with dual re-pressurization pumps.
- Return Activated Sludge (RAS)/Waste Activated Sludge (WAS) building received new Motor Control Center, Programmable Logical (PLC) Computer and Supervisory Control and Data Acquisition System (SCADA).
- The Chlorination Building removed all Chlorine (CL₂) gas system.
- Phase two completion 2023 included:
 - Influent pump station: 4 new influent pumps and Motor Control Center for building.

- Headworks equipment: replaced influent flow meter, installed new slide gates, new grit collector drive, new grit washer, installed new influent screens and rag compactor. New Motor Control Center and instrumentation.
- Chlorination/Dechlorination Building: installed new Motor Control Center and Programable Logic Controller. New chlorine analyzers and sample pumps.
- Final Effluent Pump Station: replaced Motor Control Center and Programable Logic Controller. Replaced isolation valves on all pumps in station. Replaced effluent flow meter. Installed mixing system in wet well to prevent solids building up on the floor of the station.
- Replaced main electrical feeds to all areas of Motor Control Center replacement including new power to Laboratory during power failures.

Section A: Data Tables and Graphs

TABULAR SUMMARY OF 2023 RECLAMATION NPDES REPORTABLE DATA

Month	Reclaimed Flows		CBOD ₅	Total Suspended Solids	Turbidity	
	Monthly Total Flow MG	Daily Avg MGD			5-Day mg/l	Total Residue mg/l
			Avg	Max		
Jan	23.155	1.007	0.90	0.03	0.02	0.03
Feb	2.262	0.206	1.60	0.10	0.03	0.03
Mar	0.842	0.168	1.00	0.20	0.06	0.07
Apr	24.024	0.961	1.14	0.05	0.02	0.04
May	33.644	1.085	0.76	0.06	0.02	0.04
Jun	31.829	1.061	1.16	0.13	0.02	0.04
Jul	33.105	1.033	1.42	0.17	0.02	0.04
Aug	32.645	1.033	2.12	0.06	0.02	0.02
Sep	30.048	0.991	1.73	0.04	0.02	0.02
Oct	29.379	0.907	1.88	0.05	0.02	0.03
Nov	28.608	0.983	1.30	0.01	0.02	0.03
Dec	29.423	1.162	1.23	0.06	0.02	0.03

Lab Data 1

Month	CL2 Residual		pH	Total Coliforms	Sett. Solids	TDS
	Metered mg/l		Grab Daily Units	mpn / 100 ml	ml/l	mg/l
	Min	Max				
Jan	6.66	9.38	6.9	<1.0	<0.1	242
Feb	7.10	9.43	7.7	<1.0	<0.1	474
Mar	6.48	7.72	7.1	<1.0	<0.1	244
Apr	7.32	8.58	7.2	<1.0	<0.1	214
May	7.73	9.03	7.1	<1.0	<0.1	291
Jun	7.30	9.06	7.2	<1.0	<0.1	222
Jul	7.39	8.82	7.1	<1.0	<0.1	248
Aug	7.18	8.86	7.1	<1.0	<0.1	270
Sep	7.54	8.88	7.1	<1.0	<0.1	240
Oct	7.25	8.57	7.1	<1.0	<0.1	231
Nov	7.42	9.27	7.1	2.4	<0.1	242
Dec	7.12	9.01	7.0	<1.0	<0.1	187

Lab Data 2

Reclamation Flow 2023

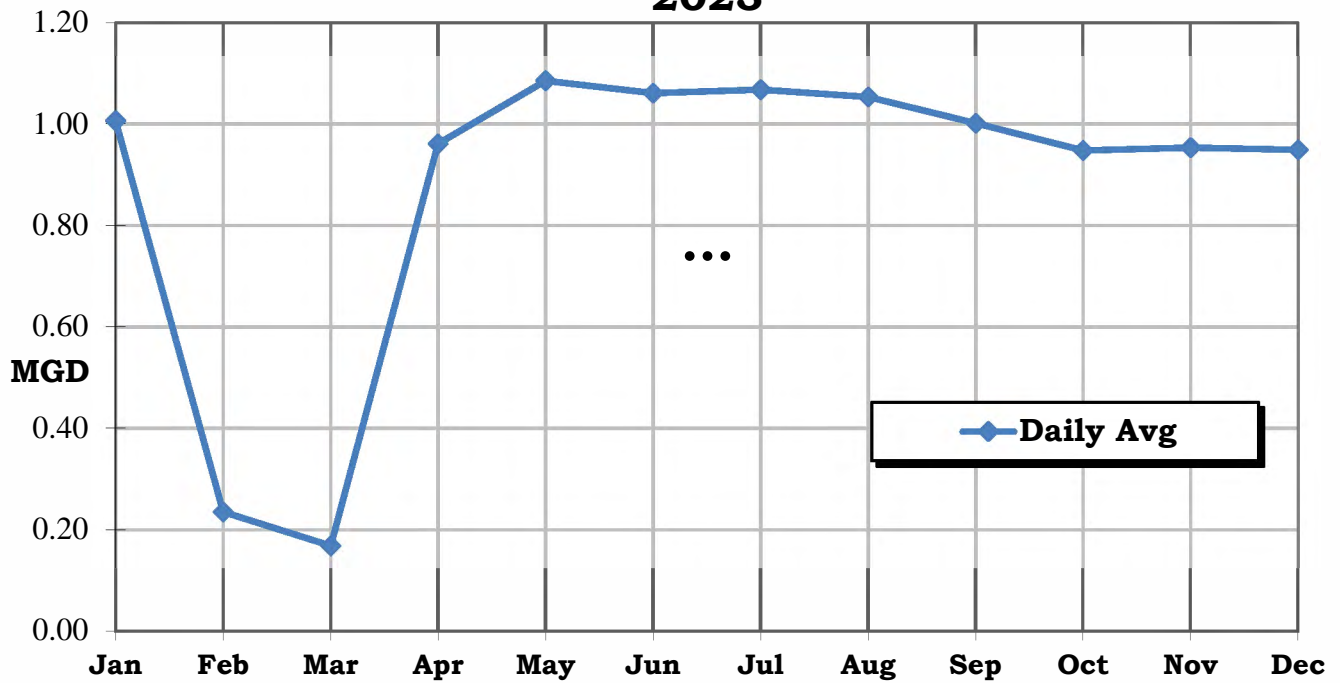

Graph 1

Reclamation CBOD 2023

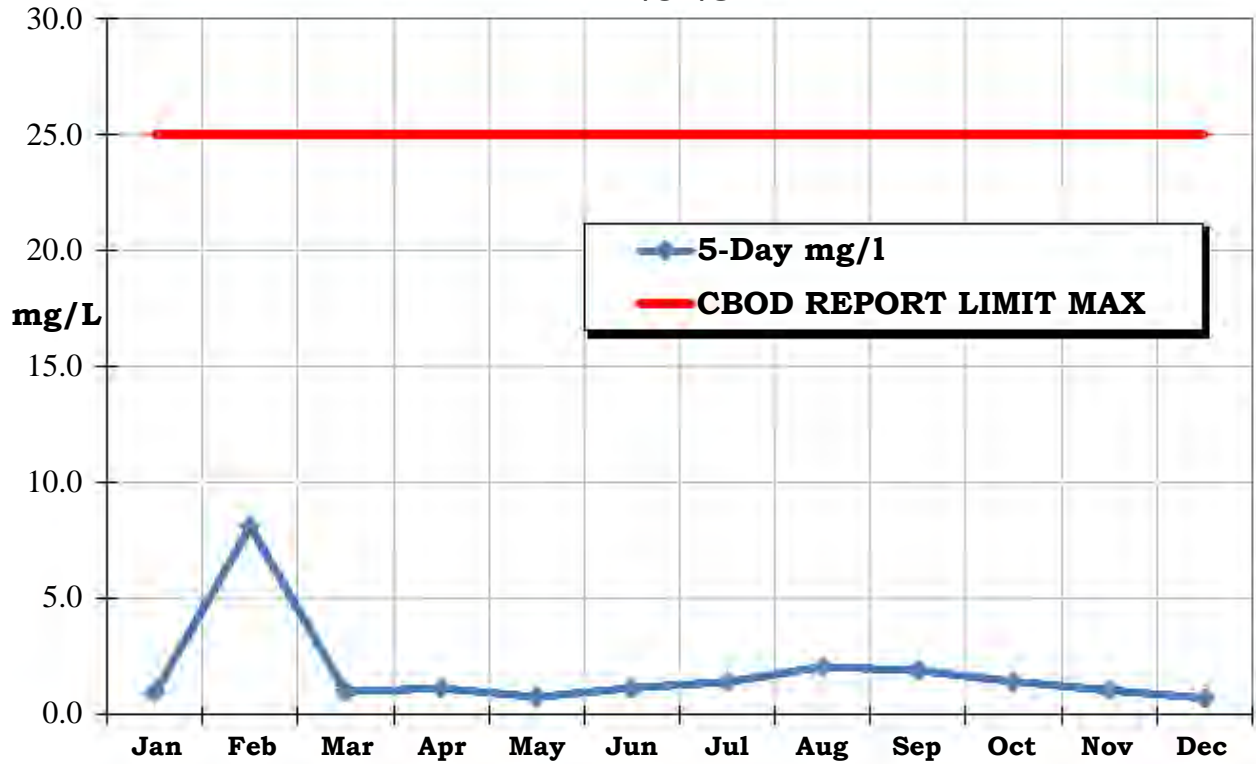

Graph 2

Reclamation T.S.S. 2023

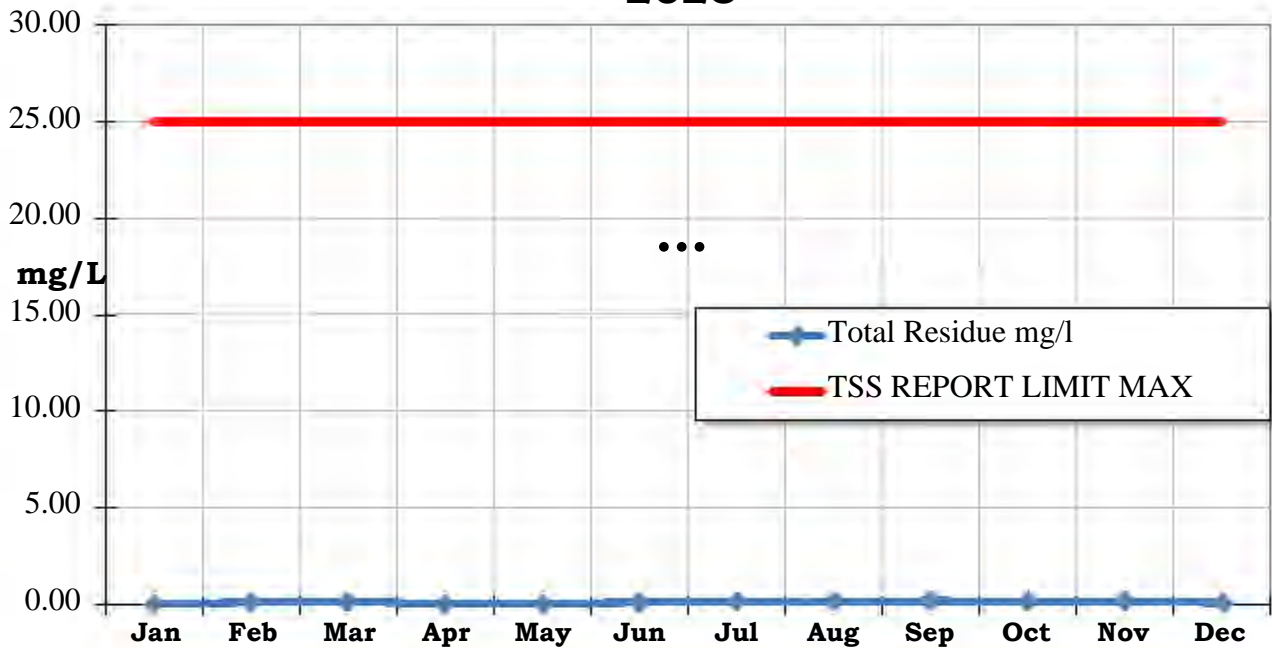

Graph 3

Reclamation Settleable Solids 2023

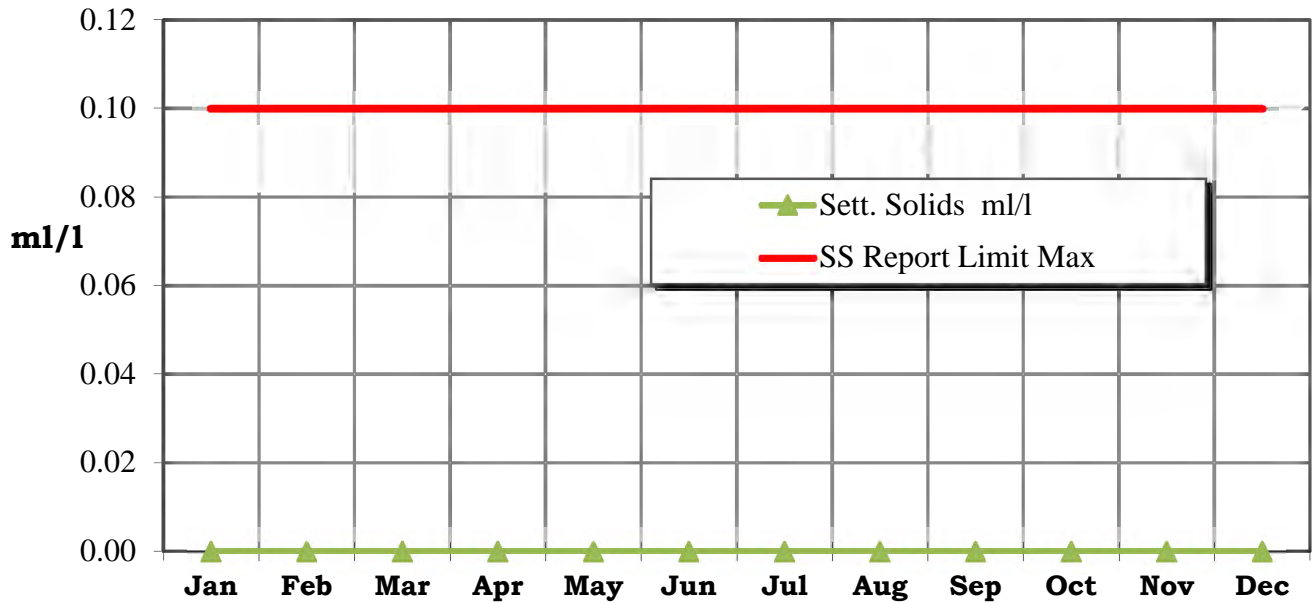

Graph 4

Reclamation Chlorine Residual 2023

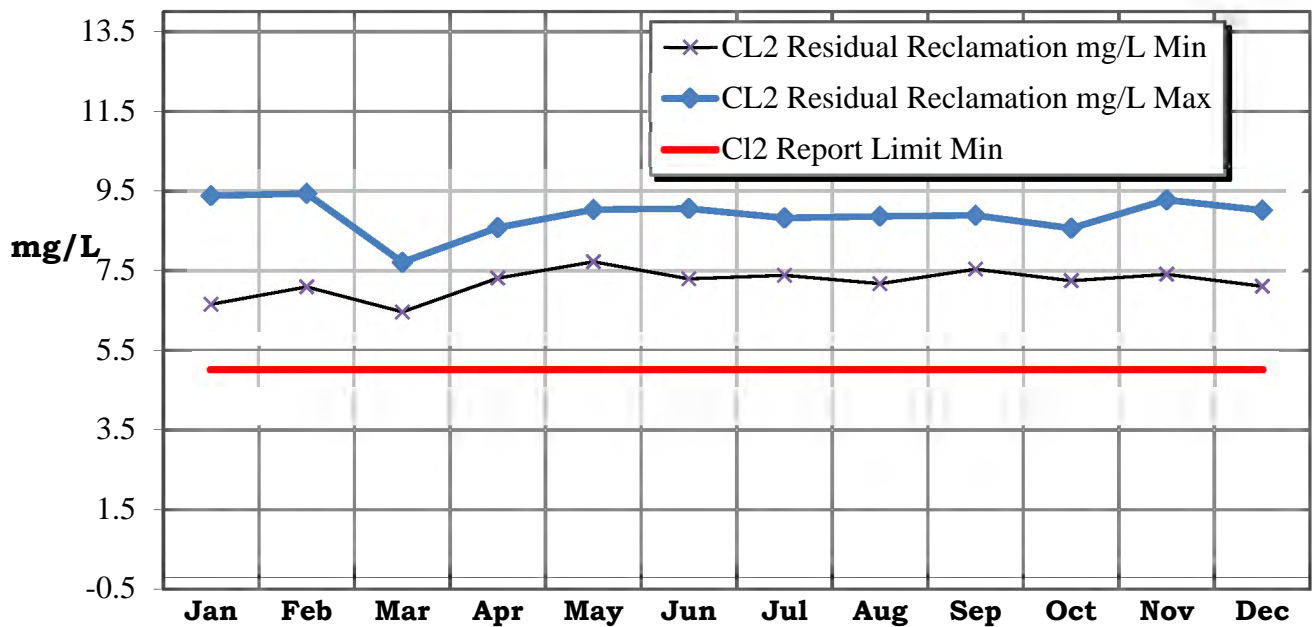

Graph 5

Reclamation Effluent Turbidity 2023

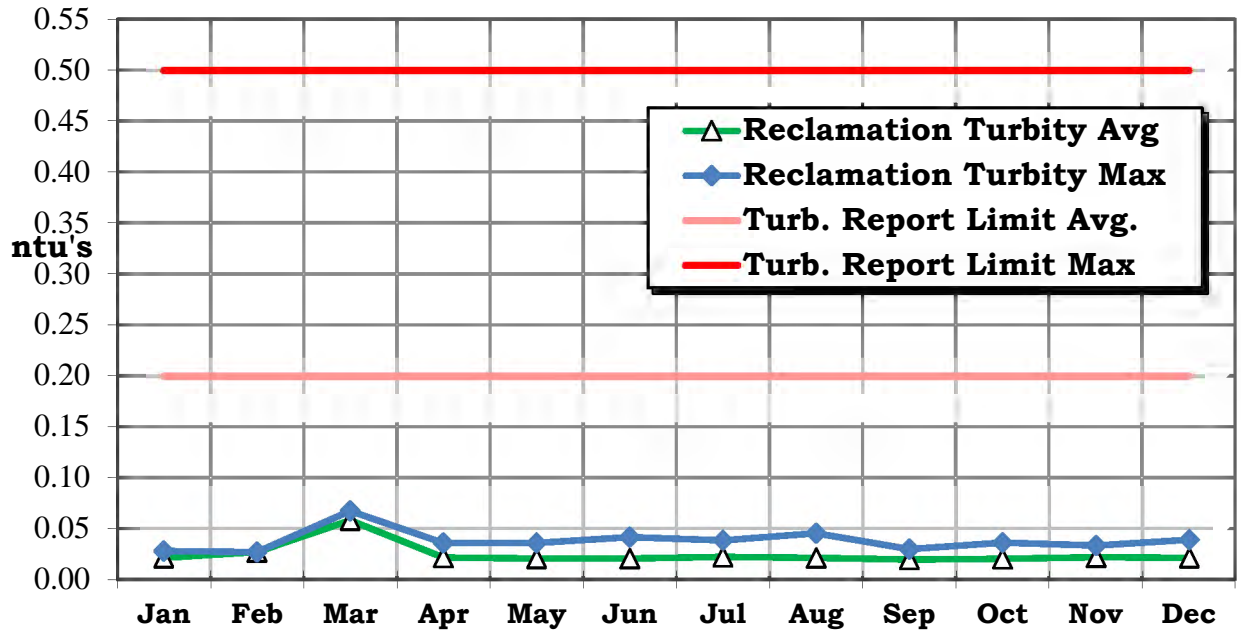

Graph 6

Reclamation Effluent pH 2023

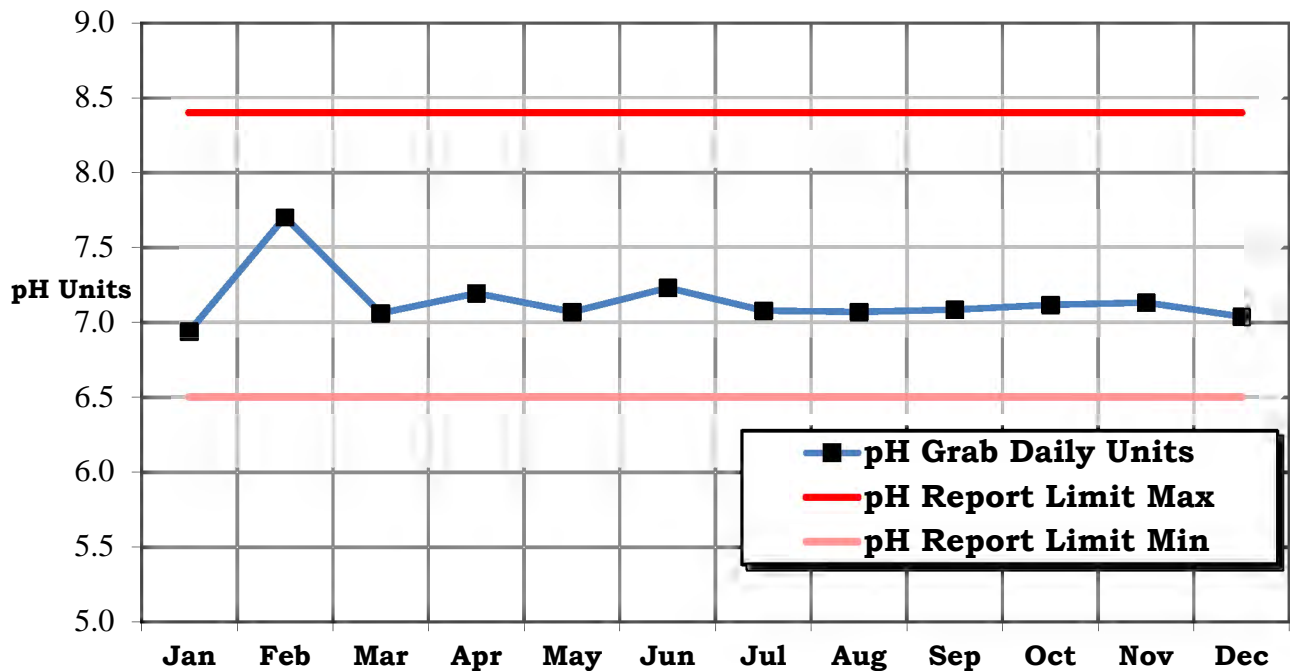

Graph 7

Reclamation Total Coliform Monthly Maximum 2023

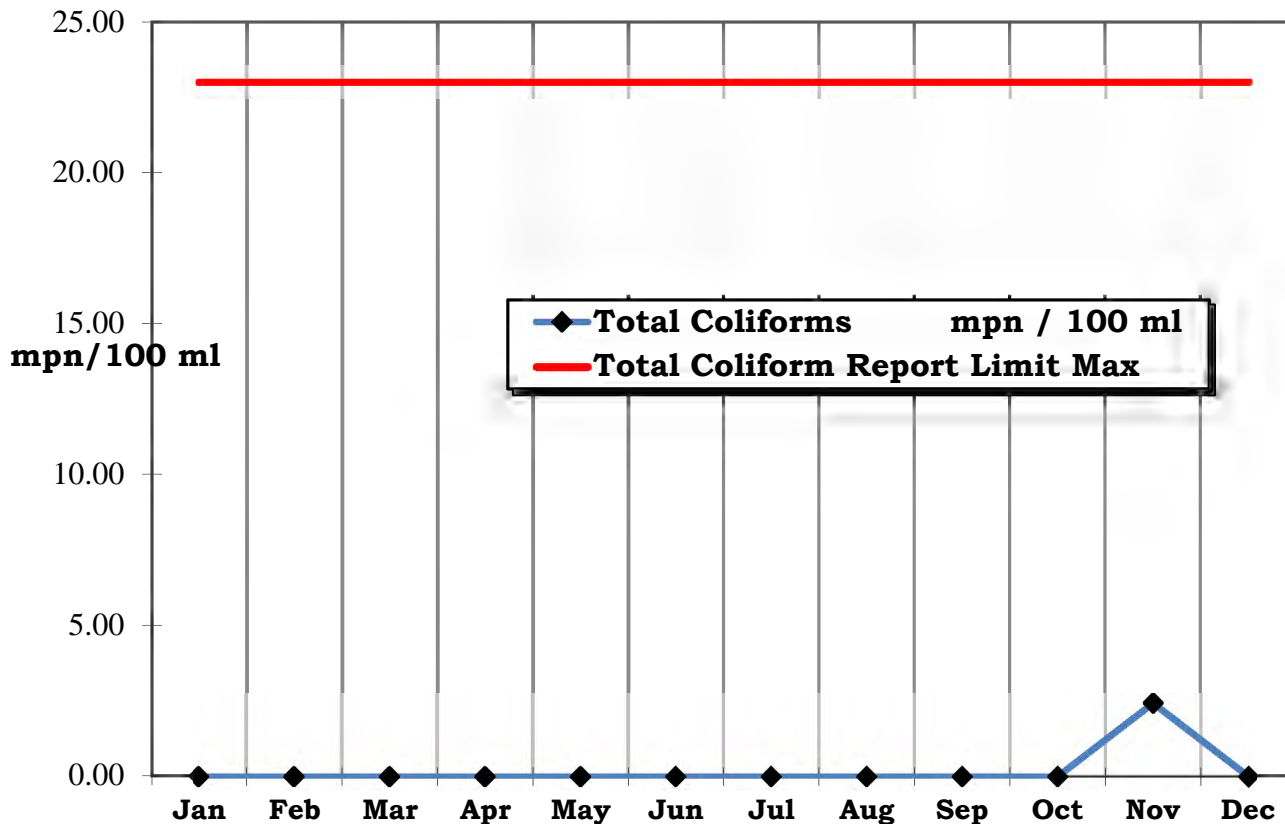

Graph 8

Section B: Compliance and Performance

- Treatment facility performance through percent removal of main pollutants.
 - CBOD percent removal (2023 annual average) was 99.6%
 - TSS percent removal (2023 annual average) was 99.9%
 - Coliform inactivation for 2023 was 99.9%
 - Settleable Solids percent removal (2023 annual average) was 99.9%

- Discussion of the previous year's compliance record.

Carmel Area Wastewater District (CAWD) had no incidents of noncompliance for the year 2023 for WDR order No. 93-72.

- Any nuisance conditions or system problems.
 - None at this time.

For Facilities That Measure Groundwater

This Facility does not have requirements to perform groundwater measurements – Not applicable.

Section C: Flow Evaluation

2021	Max Monthly Daily Flow	Monthly Total
January	1.220	27.456
February	1.191	30.843
March	1.150	13.835
April	1.142	30.749
May	1.211	32.439
June	1.133	31.322
July	1.234	32.799
August	1.172	32.334
September	1.103	28.143
October	1.185	29.200
November	1.130	29.850
December	1.568	37.845
Total annual flow		356.815

Flow Data 1

2022	Max Monthly Daily Flow	Monthly Total
January	1.518	25.497
February	1.121	22.463
March	1.198	27.006
April	1.099	25.631
May	1.168	31.153
June	1.150	30.014
July	1.177	32.026
August	1.220	32.014
September	1.228	29.721
October	1.065	28.117
November	1.243	29.480
December	1.313	36.035
Total annual flow		349.157

Flow Data 2

Carmel Area Wastewater District
 Tertiary WDR Order 93-72 Annual Report 2023

2023	Max Monthly Daily Flow	Monthly Total
January	1.615	23.155
February	0.235	2.262
March	0.203	0.842
April	1.195	24.024
May	1.200	33.644
June	1.417	31.829
July	1.296	33.105
August	1.184	32.645
September	1.195	30.048
October	1.083	29.379
November	1.169	28.608
December	1.196	29.423
Total annual flow		298.964

Flow Data 3

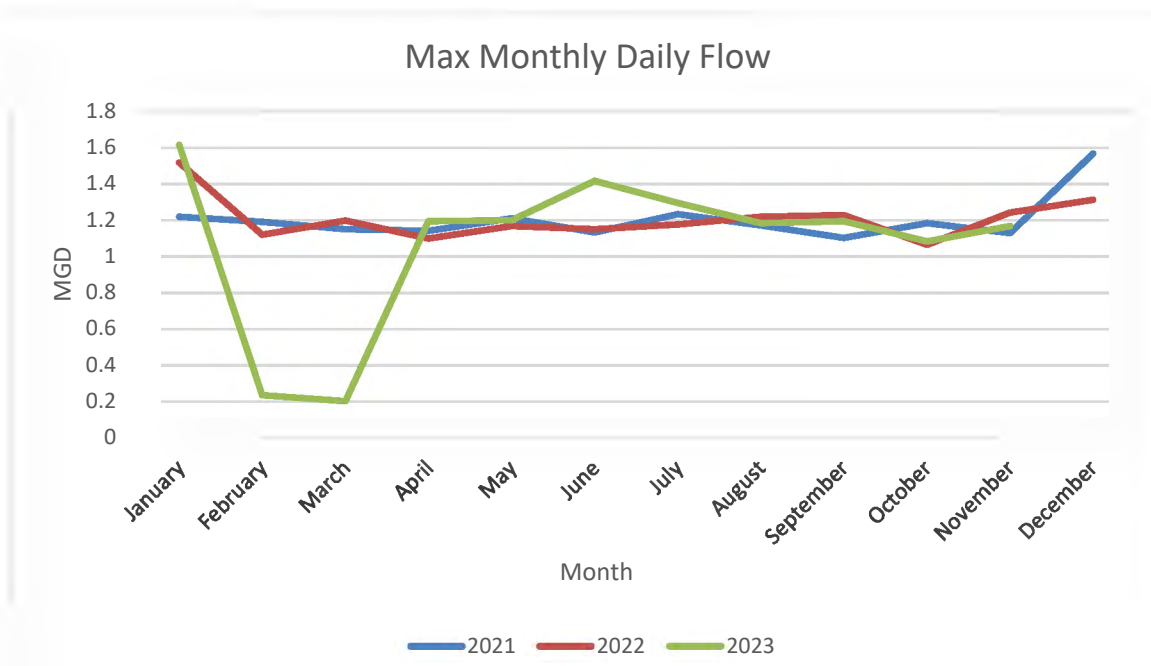

Graph 8

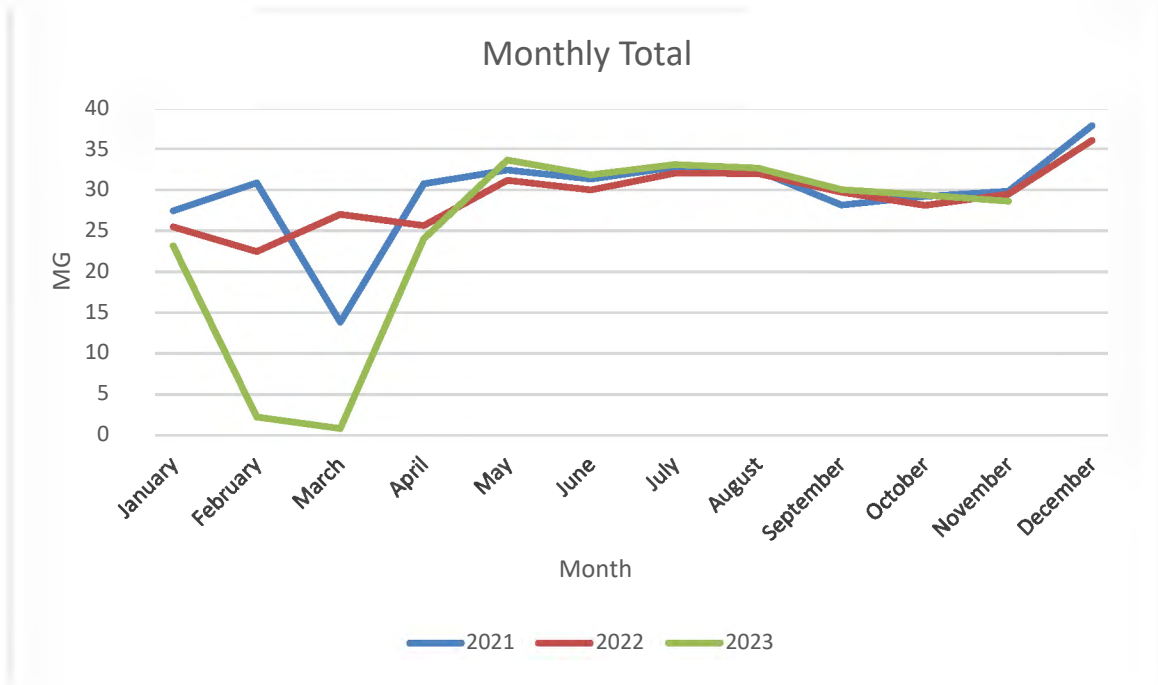

Graph 9

Section D: Operator Certification

Name	Operations Position	SWRCB Certification Level Maintained	License No.
Edward Waggoner	Operations Superintendent	V	4011
Kevin Young	Operations Supervisor	V	9660
Christian Schmidt	Senior Operator	III	28643
Chris Dixon	Senior Operator	III	40697
Michael Hooks	Senior Operator	III	41183
Michael Garrison	Operator II	III	10674
Charles DayEngel	Operator II	II	41894
Rommel Lopez	OIT	OIT	N/A

Section E: Operation and Maintenance

The Carmel Area Wastewater District's Reclamation Operation and Maintenance Manual was first written and submitted by the design engineers to the district on 12 August 1994 following a review and comment period. Corrections/amendments were made, and the last version of the Tertiary Operations and Maintenance Manual was submitted to the Carmel Area Wastewater District on 14 March 1995

The Tertiary Operations and Maintenance Manual was updated in 2007 as part of the Micro Filtration Reverse Osmosis (MF RO) Project. This was done by a joint effort with the Pebble Beach Community Service District.

The Reclamation Operations and Maintenance Manual, as submitted to the district by the design engineer, exists, by contract, as a hardbound copy as well as in an electric version such that Carmel Area Wastewater District Operations/Maintenance/Lab staff can modify procedures/drawings as required by experience/knowledge and system modifications. Thusly modifications occur on an on-going basis.

Section F: Laboratory Information

- 1 Monterey Bay Analytical Services
4 Justin Court, Suite D
Monterey, CA 93940
CA ELAP # 2385
- 2 Aquatic Bioassay & Consulting Laboratories, Inc.
29 North Olive Street
Ventura, CA 93001
CA ELAP# 1907
- 3 Carmel Area Wastewater District (CAWD)
PO Box 221842
Carmel, CA 93923
(831) 257-0432 -Phone
(831) 624-1478 -Fax
CA ELAP # 1804
- 4 Fruit Growers Laboratories (FGL)
853 Corporation St
San Luis Obispo, CA 93401
CA ELAP # 1573

Section G: Sludge Management

Sludge Management is managed by the Carmel Area Wastewater District NPDES permit CA0047996 and is addressed in that annual report. – Not Applicable.

Section H: Pretreatment

Pretreatment Management is managed by the Carmel Area Wastewater District NPDES permit CA0047996 and is addressed in that annual report. – Not Applicable.

Section I: Salt and Nutrient Management Plan

This facility does not need a salt and nutrient management plan. – Not Applicable.

Section J: Collection System Management Plan

The Collection System Management Plan is managed by the Carmel Area Wastewater District NPDES permit CA0047996 and is addressed in that annual report. – Not Applicable.

Section K: Mercury Seals

This facility does not use Mercury Seals – Not Applicable.

Section L: Figures

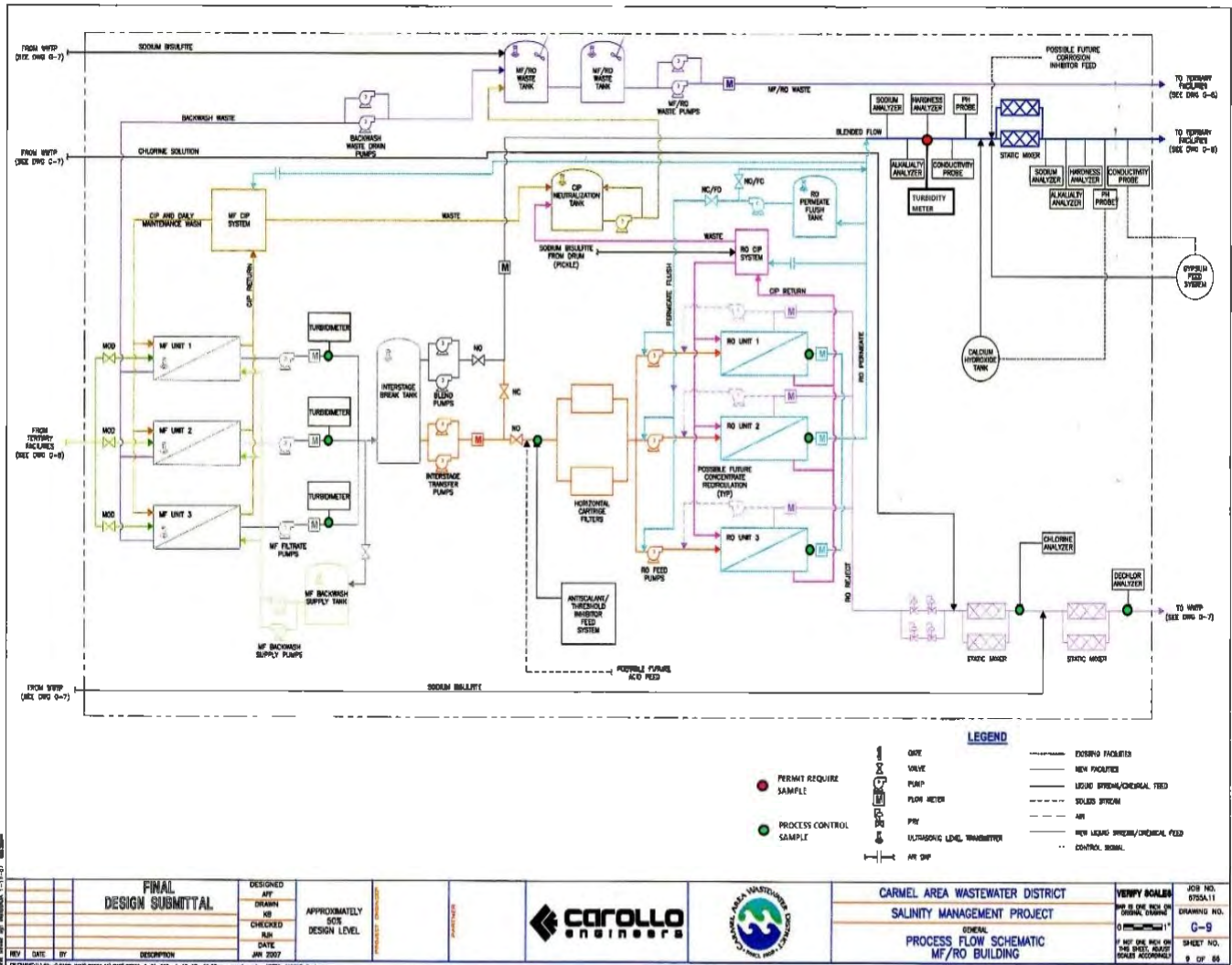

Fig 1

Carmel Area Wastewater District
 Tertiary WDR Order 93-72 Annual Report 2023

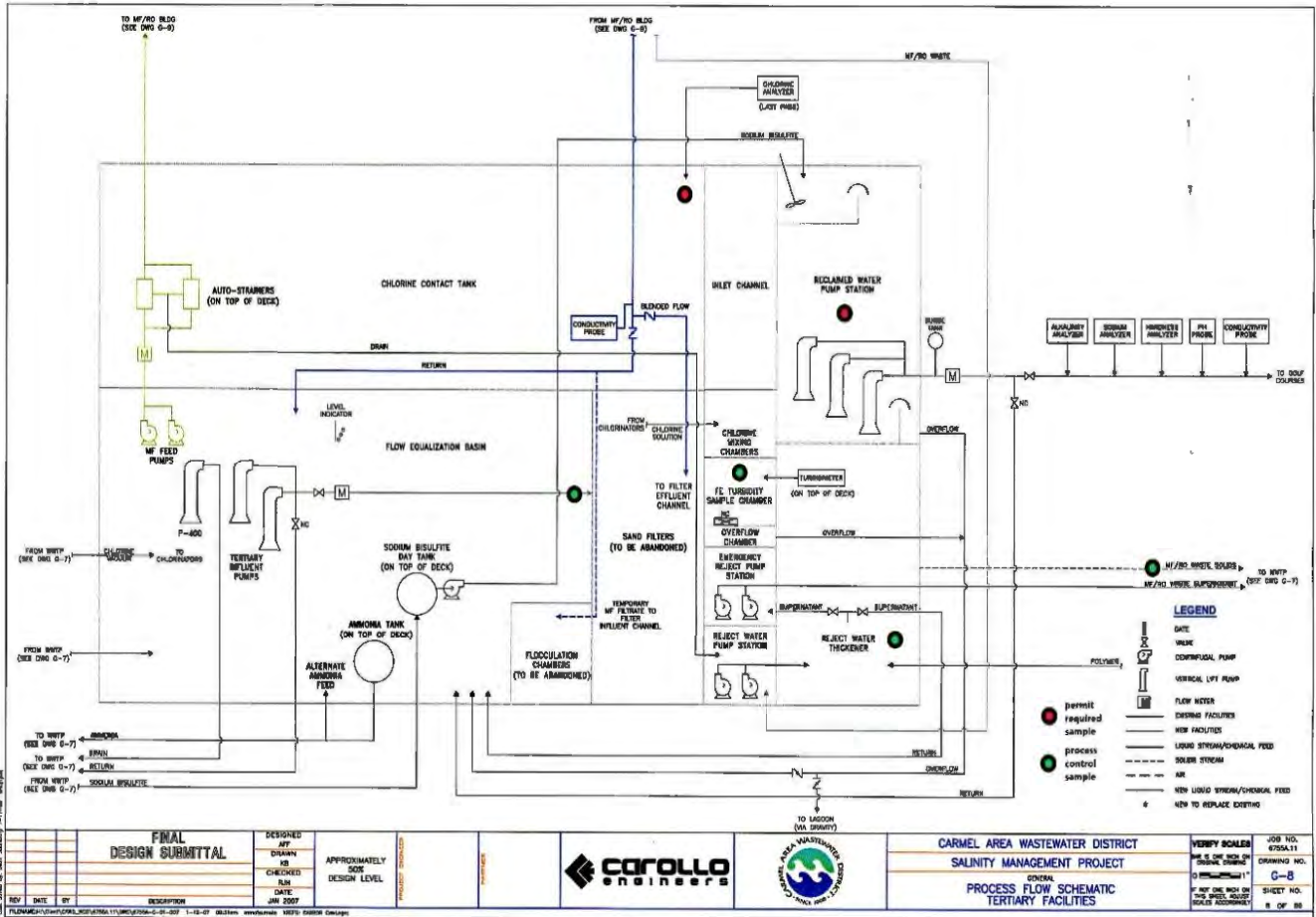

Fig 2



Fig 3

Lab Reports

This facility's Monitoring and Reporting Program requirements do not have specific annual monitoring.

CARMEL AREA WASTEWATER DISTRICT

Annual Biosolids Monitoring Report

Period: January 2023 - March 2023
 Sample Date: 27-Jan-23

Name POLLUTANTS	Concentration (mg/kg) Dry Weight unless indicated	EPA 503 pollution limits for land application	
		Pollutant Concentrations (40 CFR 503.13) (monthly avg.)	Ceiling Concentrations (40 CFR 503.13) (daily maximum)
Antimony	ND		
Arsenic	17.2	41 mg/Kg	75 mg/Kg
Barium	374.0		
Beryllium	3.6		
Boron	49.5		
Cadmium	0.961	39 mg/Kg	85 mg/Kg
Chromium	28.2		
Cobalt	0.862		
Copper	756.0	1500 mg/Kg	4300 mg/kg
Lead	35.2	300 mg/Kg	840 mg/kg
Molybdenum	26.4		75 mg/kg
Nickel	20.2	420 Mg/Kg	420 mg/Kg
Phosphorus	36,800		
Selenium	8.9	100 mg/Kg	100 mg/Kg
Silver	ND		
Thallium	ND		
Vanadium	20.2		
Zinc	1320.0	2800 mg/Kg	7500 mg/Kg
Ammonia Nitrogen	4500		
Cyanide, Total	<1		
Nitrate Nitrogen	ND		
Nitrogen, Total Kjeldahl	42,000		
pH	6.86		
% Solids	28.8%		
Mercury	0.2	17 mg/Kg	57 mg/Kg
Grease/Oil	1010		
Hex Chromium	ND		

Pathogen Reduction (40 CFR 503.32)

Class B - (PSRP) Anaerobic Digestion at 95 F for minimum of 15 days

Vector Attraction Reduction (40 CFR 503.33)

Option 1 - VS reduced by a minimum of 38%

Certification

I certify, under penalty of law, that the Class B pathogen requirements in 503.32 and the vector attraction reduction requirement in 503.33 using option (1) have been met. This determination has been made under my direction and supervision in accordance with the system designed to ensure that qualified personnel properly gather and evaluate the information used to determine that the pathogen and vector attraction reduction requirements have been met. I am aware that there are significant penalties for false certification including fine and imprisonment".

Name & Title: Edward Waggoner - Operations Superintendent

Signature: 

Telephone Number: (831) 624-1249

Date: 1-26-2024

CARMEL AREA WASTEWATER DISTRICT
Annual Biosolids Monitoring Report

Period: April 2023-June 20223
Sample Date: 18-Apr-23

Name POLLUTANTS	Concentration (mg/kg) Dry Weight unless indicated	EPA 503 pollution limits for land application	
		Pollutant Concentrations (40 CFR 503.13) (monthly avg.)	Ceiling Concentrations (40 CFR 503.13) (daily maximum)
Antimony	ND		
Arsenic	ND	41 mg/Kg	75 mg/Kg
Barium	303.0		
Beryllium	ND		
Boron	39.2		
Cadmium	3.2	39 mg/Kg	85 mg/Kg
Chromium	30.8		
Cobalt	1.3		
Copper	686.0	1500 mg/Kg	4300 mg/kg
Lead	41.3	300 mg/Kg	840 mg/kg
Molybdenum	22.2		75 mg/kg
Nickel	30.4	420 Mg/Kg	420 mg/Kg
Phosphorus	23,400		
Selenium	12.1	100 mg/Kg	100 mg/Kg
Silver	ND		
Thallium	ND		
Vanadium	20.0		
Zinc	1080.0	2800 mg/Kg	7500 mg/Kg
Ammonia Nitrogen	5630		
Cyanide, Total	ND		
Nitrate Nitrogen	ND		
Nitrogen, Total Kjeldahl	38,200		
pH	7.75		
% Solids	23.0%		
Mercury	0.2	17 mg/Kg	57 mg/Kg
Grease/Oil	ND		
Hex Chromium	ND		

Pathogen Reduction (40 CFR 503.32)

Class B - (PSRP) Anaerobic Digestion at 95 F for minimum of 15 days

Vector Attraction Reduction (40 CFR 503.33)

Option 1 - VS reduced by a minimum of 38%

Certification

I certify, under penalty of law, that the Class B pathogen requirements in 503.32 and the vector attraction reduction requirement in 503.33 using option (1) have been met. This determination has been made under my direction and supervision in accordance with the system designed to ensure that qualified personnel properly gather and evaluate the information used to determine that the pathogen and vector attraction reduction requirements have been met. I am aware that there are significant penalties for false certification including fine and imprisonment".

Name & Title: Edward Waggoner - Operations Superintendent

Signature: Edward Waggoner
Telephone Number: (831) 624-1249
Date: 1-26-2024

CARMEL AREA WASTEWATER DISTRICT

Annual Biosolids Monitoring Report

Period: July 2023 - September 2023
 Sample Date: 11-Jul-23

Name POLLUTANTS	Concentration (mg/kg) Dry Weight unless indicated	EPA 503 pollution limits for land application	
		Pollutant Concentrations (40 CFR 503.13) (monthly avg.)	Ceiling Concentrations (40 CFR 503.13) (daily maximum)
Antimony	ND		
Arsenic	ND	41 mg/Kg	75 mg/Kg
Barium	68.1		
Beryllium	0.6		
Boron	12.9		
Cadmium	0.5	39 mg/Kg	85 mg/Kg
Chromium	5.0		
Cobalt	ND		
Copper	195.0	1500 mg/Kg	4300 mg/kg
Lead	8.2	300 mg/Kg	840 mg/kg
Molybdenum	5.7		75 mg/kg
Nickel	5.9	420 Mg/Kg	420 mg/Kg
Phosphorus	10,000		
Selenium	2.1	100 mg/Kg	100 mg/Kg
Silver	ND		
Thallium	ND		
Vanadium	1.9		
Zinc	325.0	2800 mg/Kg	7500 mg/Kg
Ammonia Nitrogen	5510		
Cyanide, Total	0.11		
Nitrate Nitrogen	ND		
Nitrogen, Total Kjeldahl	2,870		
pH	6.7		
% Solids	23.8%		
Mercury	0.2	17 mg/Kg	57 mg/Kg
Grease/Oil	560		
Hex Chromium	ND		

Pathogen Reduction (40 CFR 503.32)

Class B - (PSRP) Anaerobic Digestion at 95 F for minimum of 15 days

Vector Attraction Reduction (40 CFR 503.33)

Option 1 - VS reduced by a minimum of 38%

Certification

I certify, under penalty of law, that the Class B pathogen requirements in 503.32 and the vector attraction reduction requirement in 503.33 using option (1) have been met. This determination has been made under my direction and supervision in accordance with the system designed to ensure that qualified personnel properly gather and evaluate the information used to determine that the pathogen and vector attraction reduction requirements have been met. I am aware that there are significant penalties for false certification including fine and imprisonment".

Name & Title: Edward Waggoner - Operations Superintendent

Signature: Edward Waggoner

Telephone Number: (831) 624-1249

Date: 1-26-2024

CARMEL AREA WASTEWATER DISTRICT

Annual Biosolids Monitoring Report

Period: October 2023 - December 2023
 Sample Date: 10-Oct-23

Name POLLUTANTS	Concentration (mg/kg) Dry Weight unless indicated	EPA 503 pollution limits for land application	
		Pollutant Concentrations (40 CFR 503.13) (monthly avg.)	Ceiling Concentrations (40 CFR 503.13) (daily maximum)
Antimony	ND		
Arsenic	ND	41 mg/Kg	75 mg/Kg
Barium	57.7		
Beryllium	0.5		
Boron	8.8		
Cadmium	0.4	39 mg/Kg	85 mg/Kg
Chromium	2.1		
Cobalt	ND		
Copper	135.0	1500 mg/Kg	4300 mg/kg
Lead	3.9	300 mg/Kg	840 mg/kg
Molybdenum	5.6		75 mg/kg
Nickel	2.8	420 Mg/Kg	420 mg/Kg
Phosphorus	6,920		
Selenium	ND	100 mg/Kg	100 mg/Kg
Silver	14.1		
Thallium	ND		
Vanadium	1.3		
Zinc	302.0	2800 mg/Kg	7500 mg/Kg
Ammonia Nitrogen	1150		
Cyanide, Total	ND		
Nitrate Nitrogen	ND		
Nitrogen, Total Kjeldahl	10,600		
pH	6.89		
% Solids	20.0%		
Mercury	0.9	17 mg/Kg	57 mg/Kg
Grease/Oil	600		
Hex Chromium	ND		

Pathogen Reduction (40 CFR 503.32)

Class B - (PSRP) Anaerobic Digestion at 95 F for minimum of 15 days

Vector Attraction Reduction (40 CFR 503.33)

Option 1 - VS reduced by a minimum of 38%

Certification

I certify, under penalty of law, that the Class B pathogen requirements in 503.32 and the vector attraction reduction requirement in 503.33 using option (1) have been met. This determination has been made under my direction and supervision in accordance with the system designed to ensure that qualified personnel properly gather and evaluate the information used to determine that the pathogen and vector attraction reduction requirements have been met. I am aware that there are significant penalties for false certification including fine and imprisonment".

Name & Title: Edward Waggoner - Operations Superintendent

Signature: Edward Waggoner
 Telephone Number: (831) 624-1249
 Date: 1-26-2024



EPA's sewage sludge regulations require certain publicly owned treatment works (POTWs) and Class I sewage sludge management facilities to submit to a Sewage Sludge (Biosolids) Annual Report (see 40 CFR 503.18 (https://www.ecfr.gov/cgi-bin/text-idx?node=pt40.32.503&rgn=div5#se40.32.503_118), 503.28 (https://www.ecfr.gov/cgi-bin/text-idx?node=pt40.32.503&rgn=div5#se40.32.503_128), 503.48 (https://www.ecfr.gov/cgi-bin/text-idx?node=pt40.32.503&rgn=div5#se40.32.503_148)). Facilities that must submit a Sewage Sludge (Biosolids) Annual Report include POTWs with a design flow rate equal to or greater than one million gallons per day, POTWs that serve 10,000 people or more, Class I Sludge Management Facilities (as defined by 40 CFR 503.9 (https://www.ecfr.gov/cgi-bin/text-idx?node=pt40.32.503&rgn=div5#se40.32.503_19)), and facilities otherwise required to file this report (e.g., permit condition, enforcement action, state law). This is the electronic form for Sewage Sludge (Biosolids) Annual Report filers to use if they are located in one of the states, tribes, or territories (<https://www.epa.gov/npdes/npdes-state-program-information>) where EPA administers the Federal biosolids program.

For the purposes of this form, the term 'sewage sludge' (https://www.ecfr.gov/cgi-bin/text-idx?node=pt40.32.503&rgn=div5#se40.32.503_19) also refers to the material that is commonly referred to as 'biosolids'. EPA does not have a regulatory definition for biosolids but this material is commonly referred to as sewage sludge that is placed on, or applied to the land to use the beneficial properties of the material as a soil amendment, conditioner, or fertilizer. EPA's use of the term 'biosolids' in this form is to confirm that information about beneficially used sewage sludge (a.k.a. biosolids) should be reported on this form.

Public Availability of Information Submitted on and with this Program Report

EPA may make all the information submitted through this form (including all attachments) available to the public without further notice to you. Do not use this online form to submit personal information (e.g., non-business cell phone number or non-business email address), confidential business information (CBI), or if you intend to assert a CBI claim on any of the submitted information. Pursuant to 40 CFR 2.203(a), EPA is providing you with notice that all CBI claims must be asserted at the time of submission. EPA cannot accommodate a late CBI claim to cover previously submitted information because efforts to protect the information are not administratively practicable since it may already be disclosed to the public. Although we do not foresee a need for persons to assert a claim of CBI based on the types of information requested in this form, if persons wish to assert a CBI claim we direct submitters to contact the NPDES eReporting Help Desk (NPDESereporting@epa.gov (mailto:NPDESereporting@epa.gov)) for further guidance.

Please note that EPA may contact you after you submit this report for more information regarding your sewage sludge management program.

Burden Statement

This collection of information is approved by OMB under the Paperwork Reduction Act, 44 U.S.C. 3501 et seq. (OMB Control No. 2040-0004). Responses to this collection of information are mandatory in accordance with EPA NPDES regulations (40 CFR 503.18, 503.28, and 503.48). An agency may not conduct or sponsor, and a person is not required to respond to, a collection of information unless it displays a currently valid OMB control number. The public reporting and recordkeeping burden for this collection of information are estimated to average one to five hours per response. Send comments on the Agency's need for this information, the accuracy of the provided burden estimates and any suggested methods for minimizing respondent burden to the Regulatory Support Division Director, U.S. Environmental Protection Agency (2821T), 1200 Pennsylvania Ave., NW, Washington, D.C. 20460. Include the OMB control number in any correspondence. Do not send the completed form to this address.

Facility Information

Facility Name: CARMEL WWTP

NPDES ID: CAL047996

Program Information

Please select all of the following that apply to your obligation to submit a Sewage Sludge (Biosolids) Annual Report in compliance with 40 CFR part 503. The facility is:

- a POTW with a design flow rate equal to or greater than one million gallons per day
- a POTW that serves 10,000 people or more

In the reporting period, did you manage your sewage sludge or biosolids using any of the following management practices: land application, surface disposal, or incineration?

YES NO

If your facility is a POTW, please provide the estimated total amount of sewage sludge produced at your facility for the reporting period (in dry metric tons). If your facility is not a POTW, please provide the estimated total amount of biosolids produced at your facility for the reporting period (in dry metric tons).

288

Reporting Period Start Date: 01/01/2023

Reporting Period End Date: 12/31/2023

Treatment Processes

Processes to Significantly Reduce Pathogens (PSRP):

Anaerobic Digestion

Processes to Further Reduce Pathogens (PFRP):

Physical Treatment Options:

Preliminary Operations (e.g., sludge grinding, degritting, blending)

Thickening (e.g., Gravity and/or Flotation Thickening, Centrifugation, Belt Filter Press, Vacuum Filter, Screw Press)

Other Processes to Manage Sewage Sludge:

Methane or Biogas Capture and Recovery

Analytical Methods

Did you or your facility collect sewage sludge or biosolids samples for laboratory analysis? YES NO

Analytical Methods

- EPA Method 6010 - Arsenic (ICP-OES)
- EPA Method 6010 - Cadmium (ICP-OES)
- EPA Method 6010 - Chromium (ICP-OES)
- EPA Method 6010 - Copper (ICP-OES)
- EPA Method 6010 - Lead (ICP-OES)
- EPA Method 6010 - Molybdenum (ICP-OES)
- EPA Method 6010 - Nickel (ICP-OES)
- EPA Method 6010 - Selenium (ICP-OES)
- EPA Method 6010 - Zinc (ICP-OES)
- EPA Method 6010 - Beryllium (ICP-OES)
- EPA Method 351.2 - Total Kjeldahl Nitrogen
- Standard Method 4500-N - Nitrogen
- EPA Method 9056 - Nitrate Nitrogen (IC)
- Standard Method 2540 - Total Solids
- EPA Method 9040 - pH (<= 7% solids)

Sludge Management - Land Application

Sludge Management - Surface Disposal

Sludge Management - Incineration

Sludge Management - Other Management Practice

ID: 001

Amount: 288

Management Practice Detail: Other

Other Management Practice Detail Description: DISTRIBUTION AND MRKETING-COMPOSITE

Handler, Preparer, or Applier Type: Off-Site Third-Party Preparer

NPDES ID of handler:

Facility Information:

LIBERTY COMPOSTING
PO Box 5, 12421 HOLLOWAY RD.
LOST HILLS, CA 93249
US

Contact Information:

WILSON NOLAN
COMPLIANCE SITE MANAGER
661-772-3171
WNOLAN@SYNAGRO.COM

Pathogen Class: Class B

Do you have any deficiencies to report for this SSUID? YES NO UNKNOWN

Additional Information

Please enter any additional information that you would like to provide in the comment box below.

Additional Attachments

Name	Created Date	Size
BioSolids_Report_2023.pdf	01/29/2024 9:15 PM	1.07 MB

Certification Information

I certify under penalty of law that this document and all attachments were prepared under my direction or supervision in accordance with a system designed to assure that qualified personnel properly gathered and evaluated the information submitted. Based on my inquiry of the person or persons who manage the system, or those persons directly responsible for gathering the information, the information submitted is, to the best of my knowledge and belief, true, accurate, and complete. I have no personal knowledge that the information submitted is other than true, accurate, and complete. I am aware that there are significant penalties for submitting false information, including the possibility of fine and imprisonment for knowing violations. Signing an electronic document on behalf of another person is subject to criminal, civil, administrative, or other lawful action.

Certified By: Edward L. Waggoner (CAL047996)

Certified On: 01/29/2024 6:15 PM ET